

Nr. 21

Importe

Marinedeler 24.no



MARINELISTE NR 21



FILTER OG FILTERHOLDERE TIL MARINEMOTORER

ORDRE OG SUPPORT TELEFON:
TLF: 926 69 769

www.importex24.no/marinedeler24-no/
info@marinedeler24.no

INNHOOLD:





<u>BÅTLISTE FILTER</u>	<u>SIDE</u>
Alfabetisk motorliste	18 til 43
BUNKRINGS PUMPER	16
"CAV" FILTERHOLDERE	8 og 9
"CAV" VANNUTSKILLER	10
DRIVSTOFF FILTER FOR SLANGE	1
DRIVSTOFFPUMPER UNIVERSAL	16
FILTER TENGER	15
FILTER TIL BENSIN	7
FILTER TIL GEAR	44
FILTER TIL RACOR FILTERHUS	44
FILTER TIL SEPAR FILTERHUS	44
FILTERHOLDERE m/ HÅNDPUMPE	3
FILTERHOLDERE	3
FILTERHOLDERE FOR BENSIN FILTER	6
FILTERHOLDERE FOR DRIVSTOFF FILTER	4 og 5
FILTERHOLDERE FOR OLJEFILTER	11
FITTINGS FOR FILTERHOLDERE	17
HOLDER KOMPLETT m/SIL	2
HÅNDPUMPE	2
HÅNDPUMPE MED SLANGE	15
LUFTFILTER	12 og 13
OVERGANGSLISTE RACOR / SEPAR	45
RETURVENTILER	2
VANNSEPERATOR	10
VEIVHUSFILTER VOLVO-PENTA	14

Denne listen er laget ut i fra opplysninger fra forskjellige filterleverandører, og etter opplysninger fra våre kunder.

Vi mener det meste er riktig, men vi må ta forbehold om at det kan forekomme feil.

Hvis De finner feil eller mangler hører vi gjerne i fra Dem slik at dette kan bli rettet. Er det filter som ikke står i listen ber vi Dem vennligst forespørre på disse.

Drivstoff filter

 <p>A=36 F=6 G=6 H=108,5</p>	<p>Erstatter:</p> <p>Fram G-4164 Purolator F57608</p> <p><u>NB! Brukes kun til bensin</u></p> <p>Best. Nr.: H101WK</p>
 <p>A=36 F=8 G=8 H=103</p>	<p>Erstatter:</p> <p>Fram P-4174 Fram P-6446 Mercedes 0014772101 Mercedes 0014773301 Mercedes 0014774201 Mercedes 0014775601 Mercedes 0014776901 Purolator F5768</p> <p><u>NB! Brukes kun på diesel</u></p> <p>Best. Nr.: H102WK</p>
 <p>A=36 F=8 G=8 H=102</p>	<p>Erstatter:</p> <p>Mercedes 0014776301 Mercedes 0014776401 Mercedes 0014776601 Mercedes 0014777901</p> <p><u>NB! Brukes kun på diesel</u></p> <p>Best. Nr.: H103WK</p>
 <p>A=21 F=6,2 G=6,2 H=51,5</p>	<p><u>For bensin og diesel</u></p> <p>Best. Nr.: H106WK</p>

Returventiler



Returventil for slange	Best. Nr.:
6 mm Slange	56101
8 mm Slange	56102
10 mm Slange	56103

Komplett holder med sil

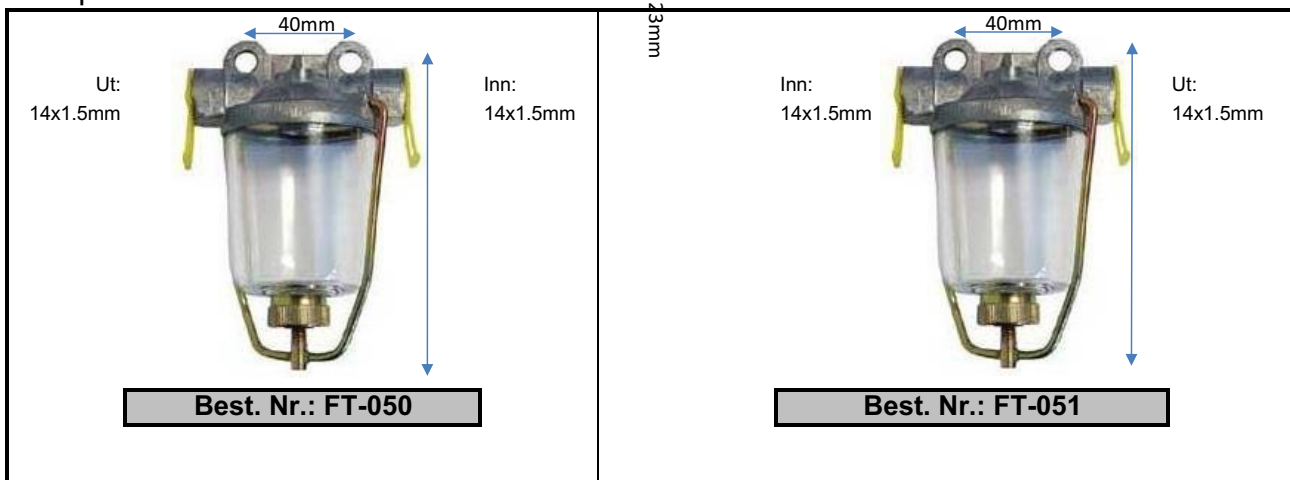

Håndpumpe

Håndpumpe



Gjenger: 16 x 1.5 mm.

Best. Nr.: 48000

Håndpumpe med festebrakett for universalmontering.

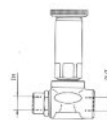

107mm

Inn - Ut: 14 x 1.5 mm.

Gjennomstrømning i brakett
maks 250L pr/t**Best. Nr.: 53111005**

Håndpumpe



Gjenger: 16 x 1.5 mm.

Best. Nr.: 48022-05

Håndpumpe med festebrakett for universalmontering.



Inn - Ut: 14 x 1.5 mm.

Gjennomstrømning i brakett
maks 250L pr/t**Best. Nr.: 49265**

Brakett med håndpumpe og sil



Følger med en blindplugg for valgfri ut

**VASKBAR SIL
MAKS 300L. PR. TIME****Best. Nr.: H11K02**

INN/ UT: 14 x 1.5mm

Best. Nr.: H11K09

INN/ UT: 16 x 1.5mm

Filterholder med håndpumpe for diesel

To muligheter for inn og ut.
Inn / ut: 14 x 1.5mm
Gjenger på filter: 16 x 1,5mm

Erstatter:

Bosch 0450126190L
0450126190MP

Følgende filter kan brukes:

H17WK02 280 l. pr/t.
H30WK01 105 l. pr/t.
H60WK01-03 165 l. pr/t.
H70WK02 m/tapp 165 l. pr/t.
33192 m/tapp

Alle er på ca. 5MY

NB!

Denne holderen kan leveres som komplett med filter og nippler for 8mm slange

Best. Nr. S09794-komplett

Best. Nr.: S09794To muligheter for inn og ut.
Inn / ut: 14 x 1.5mm
Gjenger på filter: 16 x 1,5mm

Erstatter:

Bosch 0450126009L
0450126009MP

Følgende filter kan brukes:

H17WK02 280 l. pr/t.
H30WK01 105 l. pr/t.
H60WK01-03 165 l. pr/t.
H70WK02 m/tapp 165 l. pr/t.
33192 m/tapp

Alle er på ca. 5MY

NB!

Denne holderen kan leveres som komplett med filter og nippler for 8mm slange

Best. Nr. S09795-komplett

Best. Nr.: 49100

CAV-FILTERHOLDER MED HÅNDPUMPE FOR DIESEL

To muligheter for inn og ut.
Inn / ut: 14 x 1.5mm

Erstatter:

CAV 9001-742A
CAV 9001-742B
CAV 9001-742G
SF112KU**Best. Nr.: 49090-04**

Filterholdere for drivstoff filter

Erstatter:

Bosch: 0450133007, 0450122011, 0450133013, 0450198009

Case: 5148524, 5181823

Volvo: 8107486, 838472, 1542209

Følgende filter kan brukes:

H17WK02

H30WK01

H60WK01-07

H70WK02 m/tapping

33192 m/tapping

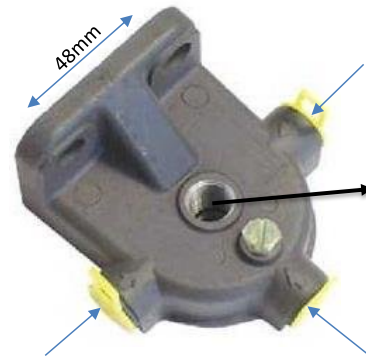
Leveres uten blindplugger!Alle er på ca. **5MY****280 l. pr/t.****105 l. pr/t.****165 l. pr/t.****165 l. pr/t.**

Gjenger for filter 16 x 1,5mm.

Gjenger inn / ut: 14 x 1,5mm.

Best. Nr.: 49102

Følgende filter kan brukes:

H19WK02

TF1652 med 36 x 1,5mm hull for sensor

Nippler for 8mm. slange rett ut: 3823-0508

Nippler for 10mm. slange rett ut: 3823-0608

Gjenger for filter 3/4" - 16.

Gjenger inn / ut: 1/2" NPT.

Best. Nr.: 24764

Filterholdere for drivstoff filter

Filterholder enkel

<p><u>Følgende filter kan brukes:</u></p> <table border="0"> <tr> <td>H17WK02</td> <td>280 l. pr/t.</td> </tr> <tr> <td>H30WK01</td> <td>105 l. pr/t.</td> </tr> <tr> <td>H60WK01-07</td> <td>165 l. pr/t.</td> </tr> <tr> <td>H70WK02 m/tapping</td> <td>165 l. pr/t.</td> </tr> <tr> <td>33192 m/tapping</td> <td></td> </tr> </table> <p>Alle er på ca. 5MY</p>	H17WK02	280 l. pr/t.	H30WK01	105 l. pr/t.	H60WK01-07	165 l. pr/t.	H70WK02 m/tapping	165 l. pr/t.	33192 m/tapping		<p>Gjenger for filter: 16 x 1,5mm Gjenger inn / ut: 14 x 1,5mm</p> <p>Kun holder uten filter og blindplugg</p> <p>Best. Nr.: 49103</p>
H17WK02	280 l. pr/t.										
H30WK01	105 l. pr/t.										
H60WK01-07	165 l. pr/t.										
H70WK02 m/tapping	165 l. pr/t.										
33192 m/tapping											



Filterholder dobbel med vender

<p>Gjenger inn / ut: 18 x 1,5mm Gjenger på filter: 16 x 1,5mm</p>	<p><u>Følgende filter kan brukes:</u></p> <table border="0"> <tr> <td>H17WK02</td> <td>280 l. pr/t.</td> </tr> <tr> <td>H30WK01</td> <td>105 l. pr/t.</td> </tr> <tr> <td>H60WK01-07</td> <td>165 l. pr/t.</td> </tr> <tr> <td>H70WK02 m/tapping</td> <td>165 l. pr/t.</td> </tr> <tr> <td>33192 m/tapping</td> <td></td> </tr> </table> <p>Alle er på ca. 5MY</p> <p>Kun holderen: Best. Nr.: HWKU49</p>	H17WK02	280 l. pr/t.	H30WK01	105 l. pr/t.	H60WK01-07	165 l. pr/t.	H70WK02 m/tapping	165 l. pr/t.	33192 m/tapping		<p>Holderen leveres komplett som på bildet med filter (H70WK02), og nippler for 8mm. Slange</p> <p>Best. Nr.: HWKU49-komplett</p>
H17WK02	280 l. pr/t.											
H30WK01	105 l. pr/t.											
H60WK01-07	165 l. pr/t.											
H70WK02 m/tapping	165 l. pr/t.											
33192 m/tapping												

Filterholder / filter for bensin

	<p>Bensin filter (10my) komplett med vannseparator funksjon. Brukes på: Crusader, Mercury, Mercruiser, Volvo-Penta, Yamaha m.fl. Komplet med 2 nipler for 10mm. slange og 2 blindplugger (3/8"NPT). Inn / ut er valgfritt i begge retninger Kapasitet: 325 l/t. Erstatter: Flak: 1034330, H1034330, Easterner: C14550, Startax: 1800-48030 Løst filter til denne med 10my er 33225 (m/11/16"-16 gjenger.) Løse nippler for 8mm slange: 3823-0506. Løse nippler for 10mm slange: 3823-0606.</p> <p style="text-align: center;">Best.Nr.: 1800-48030</p>
	<p>Bensin filter (10my) komplett med vannseparator funksjon. Brukes på: Evinrude, Johnson, Mercruiser, Mercury, OMC m.fl. Sitter på alle IBIZA båter. Komplet med 2 nipler for 10mm. slange og 2 blindplugger (3/8"NPT). Inn / ut er valgfritt i begge retninger. Kapasitet: 325 l/t. Erstatter: Flak: 1034332, H1034332, Startax: 1800-48032 Løst filter til denne med 10my er 33364 (m/1"-12 gjenger.) Løse nippler for 8mm slange: 3823-0506. Løse nippler for 10mm slange: 3823-0606.</p> <p style="text-align: center;">Best.Nr.: 1800-48032</p>
	<p>Bensin filter (10my) komplett med vannseparator funksjon. Brukes på: Yamaha m.fl. Komplet med 2 nipler for 10mm. slange og 2 blindplugger (3/8"NPT). Inn / ut er valgfritt i begge retninger. Kapasitet: 325 l/t. Erstatter Flak: 1034336, H1034336, Easterner: C14773P, Startax: 1800-48034 Løst filter til denne med 10MY er 1800-48035 (m/11/16"-16 gjenger.) Løse nippler for 8mm slange: 3823-0506. Løse nippler for 10mm slange: 3823-0606.</p> <p style="text-align: center;">Best.Nr.: 1800-48034</p>

Filter for bensin

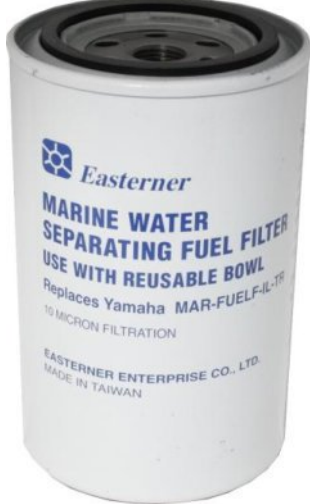
 <p>WIX® 33225 Fuel/Water Separator</p>	<p>Bensin filter (10my) element med vannseparator funksjon. Brukes på: Crusader, Mercury, Mercruiser, Volvo-Penta, Yamaha m.fl. m/ 11/16"-16 gjenger. Erstatter: Mercury, Mercruiser: 35-60494, 35-802893Q, 35-805269, 35-807172, Volvo-Penta: 855686, Crusader: 22687, Flak: 1034331, H1034331, Sierra: 18-7944, Startax: 1800-48031, Wix: 33225. Passer på holder: 1800-48030.</p> <p style="text-align: right;">Best.Nr.: 33225</p>
 <p>WIX FILTERS 33364 Fuel / Water Separator Séparateur carburant / eau Separador de combustible / agua The Heavy Duty Filter®</p>	<p>Bensin filter (10my) element med vannseparator funksjon. Brukes på: Evinrude, Johnson, Mercruiser, Mercury, OMC m.fl. m/1"-12 gjenger. Sitter på alle IBIZA båter. Erstatter: Mercruiser: 170110, 174144, 802426, OMC: 502905, Aqua Power: 6040, Flak: 1034333, H1034333, Fram: P3645, Startax 1800-48033, Wix: 33364. Passer på holder: 1800-48032.</p> <p style="text-align: right;">Best.Nr.: 33364</p>
 <p>Easterner MARINE WATER SEPARATING FUEL FILTER USE WITH REUSABLE BOWL Replaces Yamaha MAR-FUELF-IL-TR 10 MICRON FILTRATION EASTERNER ENTERPRISE CO., LTD. MADE IN TAIWAN</p>	<p>Bensin filter (10my) element med vannseparator funksjon. Brukes på: Yamaha m.fl. m/ 11/16"-16 gjenger. Erstatter: Yamaha: MAR-FUELF-IL-TR, Flak: 1034337, Sierra: 18-7866, Startax: 1800-48035 Passer på holder: 1800-48034</p> <p style="text-align: right;">Best.Nr.: 1800-48035</p>

"CAV" filterholdere

**Erstatter:**

CAV 5836B230

Gjenger inn / ut: 1/2"-20 UNF

Kapasitet: 45 l pr/t.

Komplett filterholder levert
med orginalt CAV-filter**Best. Nr.: SF 108**

Erstatningsfilter for CAV 296

E75KD42 (Hengst)Komplett filterholder tilsvarende
denne med 14x1.5mm gjenger.**Best. Nr.: 49218****Erstatter:**

CAV 5838-280

SF103

Erstatningsfilter for CAV 296

E75KD42 (Hengst)

Glass til denne holderen

Best. Nr.: 49141

Tappeplugg plast: 49157

Tappeplugg metall: SF102CK-METALL

**Erstatter:**CAV 5836B710
SF105

Gjenger inn / ut: 1/2"-20 UNF

Kapasitet: 45 l pr/t.

Komplett filterholder levert
med orginalt CAV-filter**Best. Nr.: 49224**

Erstatningsfilter for CAV 296

E75KD42 (Hengst)

Tappeplugg plast: 49157

Tappeplugg metall: SF102CK-METALL

"CAV" filterholdere

**Erstatter:**

CAV	5836B100
Volvo Penta	1140639
	SF107

Gjenger inn / ut:	1/2"-20 UNF
-------------------	-------------

Kapasitet:	45 l pr/t.
------------	------------

Komplett filterholder levert
med orginalt CAV-filter

Best. Nr.: 49226

Erstatningsfilter for CAV 296

E75KD42 (Hengst)

Glass til denne holderen

Best. Nr.: 49143-10

Tappeplugg plast:	49157
-------------------	-------

Tappeplugg metall:	SF102CK-METALL
--------------------	----------------



Komplett filterholder tilsvarende
49226, men med metall kopp
og tappeskrue

Erstatter:

CAV	5836B900
Volvo Penta	3582493

Gjenger inn / ut:	1/2"-20 UNF
-------------------	-------------

Kapasitet:	45 l pr/t.
------------	------------

Levert med orginalt CAV-filter

Best. Nr.: SF 111

Erstatningsfilter for CAV 296

E75KD42 (Hengst)

Tappeplugg plast:	49157
-------------------	-------

Tappeplugg metall:	SF102CK-METALL
--------------------	----------------

"CAV" vannutskiller.



Erstatter:

CAV 2656086G

Gjenger inn / ut: 1/2"-20 UNF

Tappeplugg plast: 49157

Tappeplugg metall: SF102CK-METALL

Best. Nr.: SF 301A

Vannseperator for diesel



Gjenger inn / ut: 14x1.5mm

Kapasitet: 240 l pr/t.

Best. Nr.: H210K

Filterholder for oljefilter

Brukes for å flytte oljefilter med 3/4 "-16 gjenger til annen plassering.



2473

Gjenger ut av motor: 3/4" - 16
Gjenger slangenippel: 1/2" NPT



24764

Gjenger for filter 3/4"-16
Gjenger slangenippel: 1/2" NPT

Best. Nr.: 24730/64

Man monterer 24730 på motorens opprinnelige filterbrakett og slanger derfra til 24764.
Leveres med filter H10W01.

Man kan også bruke filter: H14W04, H16W02, H17W01, H17W06, H19W03, H19W04.
Nippler for 16mm. slange rett ut er varenr. 3823-1008.
NB! Tilsvarende for bensin : se side 6.

Brukes for å flytte oljefilter med 20 x 1,5 mm. gjenger til annen plassering.



2473

Gjenger ut av motor: 20x1,5mm
Gjenger slangenippel: 1/2" NPT



24764

Gjenger for filter 3/4"-16
Gjenger slangenippel: 1/2" NPT

Best. Nr.: 24736/64

Man monterer 24736 på motorens opprinnelige filterbrakett og slanger derfra til 24764.
Leveres med filter H10W01,51515.

Man kan også bruke filter: H14W04, H16W02, H17W01, H17W06, H19W03, H19W04.
Nippler for 16mm. slange rett ut er varenr. 3823-1008.

LUFTFILTER

Passer på Cummins B og C serie.



Erstatter:

Cummins: 3924540
 Donaldson: ECB085024
 Fleetguard: AH19003
 Wix: 546634 (Gammelt nr.)

Best. Nr.: 46634

Passer på Cummins, Sabb-Ford m.fl.



Erstatter:

Cummins: 3908719
 Fleetguard: AH1107
 Wix: 546314 (Gammelt nr.)

Best. Nr.: 46314

Passer på Scania D, Di, DS OG DSI Serie



Erstatter:

Scania: 1332341, 136974
 Donaldson: B125011
 Wix: 49011, 549011

Best. Nr.: 49011

Passer på Cummins 6B, 6BTA m.fl.



Erstatter:

Fleetguard: AH19002
 Cummins: 3924540
 Wix: 542326

Best. Nr.: 42326

Passer på Cummins, John Deere

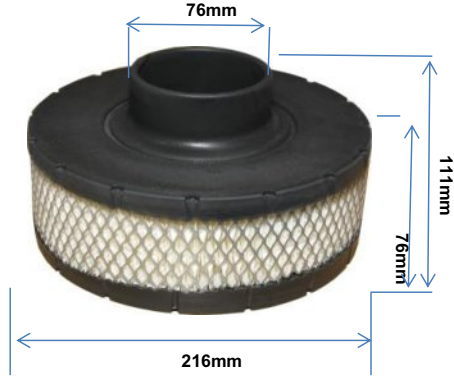

Erstatter:
 Cummins: 3910559
 Donaldson: ECB085009
 Fleetguard: AH1185
 Wix: 546731

Best. Nr.: 46731

Passer på KHD, Vetus



Erstatter:
 Donaldson: D065008
 Fleetguard: AH1189
 Luberfiner: LAF1829

Best. Nr.: 46405

Passer på bl. a. Volvo Penta

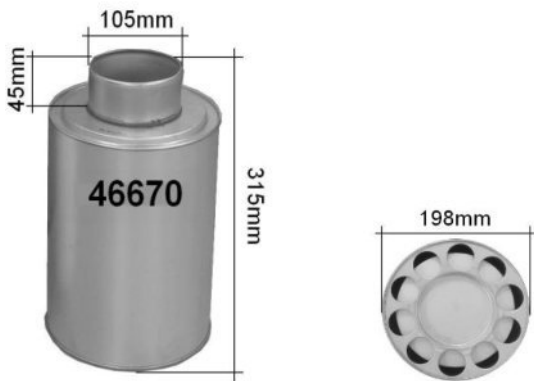

Erstatter:
 Volvo-Penta: 842280

Best. Nr.: 46670

Passer på KHD, Deutz, Iveco, MAN, Scania



Erstatter:
 Deutz: 4228706
 Donaldson: B085056
 Iveco: 8046915
 MTU: 180941402
 Scania: 1529410
 FLEETGUARD: AF27877, AH8899
 MAN: 51083010015
 51083040015
 51083010016
 51084016012

Best. Nr.: B085056



Erstatter :
 Volvo-Penta : 823701, 3825778

Best. Nr.: 46920

Veivhusfilter John Deere

Passer på:
 4045TFM75
 6068AFM75
 6068AFM85
 6068DFM01
 6068SFM50
 6068SFM75
 6068SFM85
 6068TFM01
 6068TFM50
 6068TFM75
 6068TFM76



Erstatter:

John Deere: RE502284

Passer i Racor filterhus: CCV4500

Best. Nr.: WS10107

Passer på:
 6090AFM75



Erstatter:

John Deere: RE530346

Passer i Racor filterhus: CV6000

Best. Nr.: WS10108

Veivhusfilter Volvo-Penta

Passer på:

D3

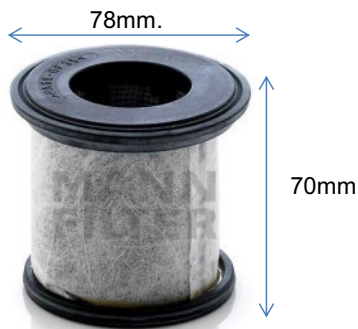

Erstatter:

Volvo-Penta: 21368879

Best. Nr.: SAO5301

Passer på:

D4, D6, D9



Erstatter:

Volvo-Penta: 3584145

Best. Nr.: SAO5235

Passer de fleste fra MD30-TAMD130

Erstatter:

Volvo-Penta: 876069

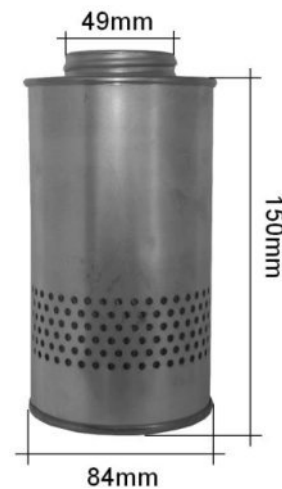

Best. Nr.: 46106

Filter tener

Best. Nr.:	Beskrivelse.
1716-601024	Filtertang med reim.





Best. Nr.:	Beskrivelse.
1716-601025	Filtertang med kjede.



**Håndpumpe**

Best. Nr.:	Beskrivelse.
1800-48008	Håndpumpe med 8mm slange.



Hardi universale drivstoffpumper 12V / 24V

Best. Nr.:	Beskrivelse.
18812	12V. 130L. Pr. time. Suger 0,12 Bar. Skyver 0,35 Bar.
18824	24V. 130L. Pr. time. Suger 0,12 Bar. Skyver 0,35 Bar.



Elektrisk drivstoffpumpe i stål utførelse med vendbare 8mm. stålnippler
Monteres valgfritt ved tank eller motorrom.
Sugehøyde ved montering ved motor ca. 1,5 meter.
Skyvehøyde ved montering ved tank ca. 3,0 meter.
130L. Pr. time er ved 0 høydeforskjell. Mer høyde gir mindre liter pr. time.
Hvis montert liggende må ut nippel peke opp.

Bunkrings pumper 12V / 24V**Best. Nr.: 8300-0715**

Tekn. Data: 12V / 150W.

40 liter pr. minutt ved 0 høydeforskjell.
Mer høyde gir mindre liter pr. time
Maks sugehøyde: 5m. / 3 Bar.

Best. Nr.: 8300-0716

Tekn. Data: 24V / 150W.

40 liter pr. minutt ved 0 høydeforskjell.
Mer høyde gir mindre liter pr. time
Maks sugehøyde: 5m. / 3 Bar.

Best. Nr.: 8300-0799

Tekn. Data: 24V / 150W.

40 liter pr. minutt ved 0 høydeforskjell.
Mer høyde gir mindre liter pr. time
Maks sugehøyde: 5m. / 3 Bar.
Samme som 8300-0716 men levert
med slange og fyllehåndtak.



VI MINNER OM AT VI OGSÅ KAN LEVERE MEKANISKE FØDEPUMPER TIL DE FLESTE MARINE MOTORER

HVIS DETTE ER AV INTERESSE VENNLIGST FORESPØR!

**8352-70544**

Passer til V.P. MD2, 5, 6, 7, 11, 17, 2001, 2, 3

**BCD1902**

Passer til Marna M1, M2, M3

FITTINGS FOR FILTERHOLDERE MED MM. GJENGER.	
FOR 14 x 1,5 mm. GJENGER.	
BESKRIVELSE	BEST. NR.:
Slange 90 :Hullskrue	89108
:Slangebanjo 6mm.	8810804
:Slangebanjo 8mm.	8810806
:Slangebanjo 10mm.	88108
Rør 90 :Hullskrue	89108
:Loddebanjo 8mm.	9810806
:Loddebanjo 10mm.	98108
Slange rett: Slangenippel 8mm.	857550600
Rør 8mm. Rett :Dobbel stuss	0570606
: Kon for lodding	91006
: Mutter	83006
Blindplugg : 14 x 1,5mm	7097-81Q
FOR 18 x 1,5 mm. GJENGER.	
BESKRIVELSE	BEST. NR.:
Slange 90 :Hullskrue	89113
:Slangebanjo 10mm.	8811308
:Slangebanjo 15mm.	88113
Rør 90 :Hullskrue	89113
:Loddebanjo 15mm.	98113
Slange rett:Slangenippel 12mm.	85110
Overgang fra 18x1,5mm til 14x1,5mm	HWKU051-120
FITTINGS FOR FILTERHOLDERE MED TOMMEGJENGER	
FOR 1/2" - 20 UNF GJENGER. "CAV"	
BESKRIVELSE	BEST. NR.:
Slange 90 :Hullskrue	853 - 1/2"
:Slangebanjo 6mm.	8810804
:Slangebanjo 8mm.	8810806
:Slangebanjo 10mm.	88108
Slange rett :Slangenippel 6mm.	88244-6mm.
:Slangenippel 8mm.	88244-8mm
:Slangenippel 10mm.	88244-10mm
Slange rett: Slangenippel 8mm. Nippel m/svivel	88245
Rør 90 :Hullskrue	853 - 1/2"
:Loddebanjo 8mm.	9810806
:Loddebanjo 10mm.	98108
Rør rett: Overgang + mutter/ Kon 8mm.	67F
Blindplugg 1/2"-20 UNF	7111-312
FOR 1/2" - NPT GJENGER M/ KON.	
Slange rett :Slangenippel 8mm.	3823-0508
:Slangenippel 10mm.	3823-0608
:Slangenippel 16mm.	3823-1008
FOR 3/8" - NPT GJENGER	
Slange rett :Slangenippel 8mm.	3823-0506
Slange rett :Slangenippel 10mm.	3823-0606



Hullskrue



Slangebanjo



Kon F. lodding



Loddebanjo



Mutter



Dobbelstuss



Slangenippel

AIFO Se IVECO**ALBIN**

MOTORTYPE	HK.	OLJE	DRIVSTOFF	LUFT
AD-2	16	H90W02	E75KD42	75729*
AD-21	19	H90W02	E75KD42	75729*
O-41	24	E110MD02		
O-411	42	E110MD02		

*ORIGINALNR.

ARONA

MOTORTYPE	HK.	OLJE	DRIVSTOFF	LUFT
AD 290	20	H90W01	33194	
AD 295	28	H90W01	33194	
AD 395	40	H90W01	33194	
AD 495	56	H90W02	E75KD42	

BMC se LEYLAND**BETA MARINE**

MOTORTYPE	KW.	OLJE	DRIVSTOFF	LUFT
BETA 14		FO-011A	DF-7751	
BETA 16		FO-011A	DF-7751	
BETA 20		FO-011A	DF-7751	
BETA 25		FO-011A	DF-7751	
BETA 30		MH390	DF-7751	
BETA 35		MH390	DF-7751	
BETA 38		MH390	DF-7751	
BETA 43		H10W22 H:86mm H14W03 H:139mm	DF-7751	
BETA 50		H10W22 H:86mm H14W03 H:139mm	DF-7751	
BETA 60		H10W22 H:86mm H14W03 H:139mm	DF-7751	
BETA 75		H10W02	NF-2252	
BETA 90		H10W02	NF-2252	

BMW

MOTORTYPE	KW.	OLJE	DRIVSTOFF	LUFT
B 130	85KW	H90W04		
B 190	122KW	E119H (Innsats) H14W07 (Spin on)	13321328714*	13721326921*
B 220	136KW	E119H (Innsats) H14W07 (Spin on)	13321328714*	13721326921*
B 635	200KW	H14W06	H60WK07	
D 7	4.5KW		WF8068	13711329269*
D 12	7.5KW		WF8068	13711329269*
D 35 (2 Syl. Hatz)	22KW	H14W07	WF8068	E033L/ E254L
D 50 (3 Syl. Hatz)	33KW	H14W07	WF8068	WA6274
D 150TD 10.1981-	105KW	H18W01	WF8060/ H70WK02**	E037L01
D 150Z	100 KW	H18W01	WF8060/ H70WK02**	E037L01
D 175		H18W01	WF8060/ H70WK02**	E037L01
D 183AC	103KW	H18W01	WF8060/ H70WK02**	E037L01
D 190WA	121 KW	H18W01	WF8060/ H70WK02**	E037L01
D 219		51754	WF8060/ H70WK02**	E037L01
D 219AC		H18W01	WF8060/ H70WK02**	E037L01
D 254AC			WF8060/ H70WK02**	E037L01
D 530	111KW	H18W01	WF8060/ H70WK02**	E037L01
D 635		H18W01 / 93x222/GJ.1"-12	WF8060/ H70WK02**	E037L01
D 636	132KW	51754 / 109x186/GJ.1"-12	WF8060/ H70WK02**	E037L01
D 636TAW	132KW	H14W07 / 76x120/GJ.3/4"-16	WF8060/ H70WK02**	

* Originalnr.

**WF8060 har 35mm hull for vannsensor / tapping - H70WK02 har tappe "skruer".

BUKH

MOTORTYPE	HK.	OLJE	DRIVSTOFF	LUFT
DV 10/ 1 Cyl.	10	H90W02	H81WK01 (Spin on) E2KP (Innsats)	
DV 10M/ 1 Cyl.		H10W03	E2KP	
DV 18/ 2 Cyl.	18	H90W02	H81WK01	
DV 20/ 2 Cyl.	20	H90W02	H81WK01 (Spin on) E2KP (Innsats)	
DV 22/ 2 Cyl.	22	H10W01		
DV 24/ 2 Cyl.	24	H90W02	H81WK01	
DV 36/ 3 Cyl.	36	H10W03	H81WK01	
DV 48/ 3 Cyl.	48	H10W03	H81WK01	
GH 105	10		H81WK01	
GH 130		H90W02	H81WK01	
4K 105 Diesel	56		E5KPD12	

CATERPILLAR

MOTORTYPE	HK.	OLJE	DRIVSTOFF	LUFT
3116		51791	H19WK01	
3116TA		51791	H19WK01	
3126		51791	H178WK	
3145		51261	33351 (Spin on)	
3150		51261	33351 (Spin on)	
3160		51261	33360 (Innsats) 33351 (Spin on)	
3176		51792 (Spin on)	33674 (Spin on)	
3196		51792 (Spin on)	33360 (Innsats)	
3208 (75)		51268		
3208 (90N)		51798	H19WK01	
3300			33351	42851/ 42852
3304		51791	H19WK01	42851
3304B		51791 51792 (Spin on)	33360 (Innsats) H19WK01	42851
3306B		51791 51792 (Spin on)	33360 (Innsats) H19WK01	42852
3400		51792 (Spin on)	33674 (Spin on)	46580
3406B		51792 (Spin on)	33360 (Innsats)	46580
3406C		51792 (Spin on)	33360 (Innsats)	
3406E		51792 (Spin on)	33674 (Spin on)	
3408B		51792 (Spin on)	33360 (Innsats) 33674 (Spin on)	46580
3408C		51792 (Spin on)	33360 (Innsats) 33674 (Spin on)	46580
3412C		51792 (Spin on)	33360 (Innsats)	
3500		51591 (Innsats)	33592 (Innsats)	E583L
3508B		51591 (Innsats) 51792 (Spin on)	33360 (Innsats)	E583L
3512		51591 (Innsats)	33360 (Innsats)	E583L
3512B		51591 (Innsats) 51792 (Spin on)	33360 (Innsats) 33592 (Innsats)	E583L
3516		51591 (Innsats) 51792 (Spin on)	33360 (Innsats)	E583L
3516B		51591 (Innsats) 51792 (Spin on)	33360 (Innsats) 33592 (Innsats)	E583L
3612		51591 (Innsats)		E583L

Kan også være levert med andre, oppgi originalnr. hvis mulig.

CHRIS CRAFT

MOTORTYPE	HK.	OLJE	DRIVSTOFF	LUFT
225B, BVC		H17W28		
283		H17W02		
283F		H17W28		
305K		H10W16/H17W28*		
307G, K, Q,F		H10W16/H17W28*		
327F, Q		H17W02/H17W28*		
350G, Q, QL		H10W16/H17W28*		
427		H17W02		
430		H17W28		
431		H17W28		
454		H17W28		
K & M SERIE		51006		

*Kan også være levert med andre, oppgi originalnr. hvis mulig.

CRUSADER vennligst forespør**CUMMINS**

MOTORTYPE	HK.	OLJE	DRIVSTOFF	LUFT
B-SERIE				
3B	2,9L	51602 (Spin on)		
4B, BT, BTA, BTAM	3,9L	51602 (Spin on)	H60WK01 (Spin on)* H17WK06 (Vannseparator)* H70W (Vann separator)*	46634 DK14
6B, BM, BT, BTA, BTM	5,9L	H19W08 (Spin on)	H60WK01 (Spin on)* H17WK06 (Vannseparator)* H70WDK14 (Vann separator)*	46634 eller 42326 (Se mål på side 12)
C-SERIE				
6C, CT, CTA	8,3L	51748 (Spin on)	H60WK01 (Spin on)* H17WK06 (Vannseparator)* H70WDK14 (Vann separator)*	46634 eller 42326 (Se mål på side 12)
L, LT, LTA, LTAA-SERIE				
10, 10C, 10-180, 10-250, 10-275, 10-290, 10-300, 10-325	10	51970		H30WF (Vannfilter)
M-SERIE				
11, E		51970 (1 1/2" x 12) 51748 (2 1/4"x12)		
N, NH, NHC, NHK-SERIE				
205, 220, 250B, 310,855C, 855, 855M		51970 51970 (1 1/2" x 12) 51748 (2 1/4"x12)	33109	
NT-SERIE				
240, 250, 270, 310, 320, 335, 380, 400, 855A, 855C 855, 855M		51970 51970 (1 1/2" x 12) 51748 (2 1/4"x12)	33109	
NTA, NTAA-SERIE				
400, 465, 855C, 855, 855M		51970 51970 (1 1/2" x 12) 51748 (2 1/4"x12)	33109	
NTC, NTE, NTT, NTZ-SERIE				
230, 240, 310, 320, 335, 355E, 370, 855, 855C 250, 290, 300, 350, 400		51970 51970 (1 1/2" x 12) 51748 (2 1/4"x12)	33109	
QSB	5,9L	H19W08 (Spin on)	33697	
QSB	6,7L		33682	
QSC	8,3L	51748XD	33422	
V, VT, VTA-SERIE				
28C, 1700		51748XD		H26WF (Vannfilter)
3000, 504, 555, 903C, 1710C		51748XD		(3001629 for 1700C)
155B		H19W08 (Spin on)	H60WK01 (Spin on)* H17WK06 (Vannseparator)*	
220B		H19W08 (Spin on)	H60WK01 (Spin on)* H17WK06 (Vannseparator)*	
270B		H19W08 (Spin on)	H60WK01 (Spin on)* H17WK06 (Vannseparator)*	
330B		H19W08 (Spin on)	H60WK01 (Spin on)* H17WK06 (Vannseparator)*	
370B		H19W08 (Spin on)	H60WK01 (Spin on)* H17WK06 (Vannseparator)*	
450C		51748 (Spin on)	H60WK01 (Spin on)* H17WK06 (Vannseparator)*	
SDI 1,9	1,9L		065201511**H119WK	
TDI 1,9	1,9L		065201511**H119WK	
TDI 2,5	2,5L			
TDI 3,0	3,0L		063201511**H119WK	
TDI 4,2	4,2L			

* H17WK06 96X161mm. Gjenger: 13/16"-18
H70WDK14 79X154mm. Gjenger: 16X1,5MM.
H60WK01 76X119mm. Gjenger: 16X1,5MM

** Orginalnr.

DÆWOO

MOTORTYPE	HK.	OLJE	DRIVSTOFF	LUFT
O 34	70	H19W08	33394	

DEUTZ Se KHD og VETUS**DETROIT: Vennligst forespør****EVINRUDE**

MOTORTYPE	HK.	OLJE	DRIVSTOFF	LUFT
	9,5	TO-137		
	15	TO-137		
	25	51360	*	
	30	51360	*	
	40	51360	*	
	50	51360	*	
	60	51360	*	
	70	51360	*	
	90	H90W01	*	
	100	H90W01	*	
115 E-TEC	115		33247	
	120	H10W16	*	
	140	H10W16	*	
	155	H17W02	*	
	160	H17W02	*	
	165	H10W16	*	
	225	H17W02	*	
	245	H17W02	*	
	L4-153	H10W16	*	
	V6-225	H17W28	*	
	V8-300	H17W28	*	
	V8-350	H10W16		

Kan også være levert med andre avhengig av årsmodell, oppgi originalnr. hvis mulig.

* Slangefilter for utenbordsmotorer kan være 33002 (8mm.) eller 33003 (10mm.)

FÄRYMANN

MOTORTYPE	HK.	OLJE	DRIVSTOFF	LUFT
15A/D/W		H11W03	H100WK	
18A/D/W		H11W03	H100WK	
32A/W		H11W03	H100WK	
35FK3M (3 Syl.)	19	MO-429 / WL7079 →	(M20x1,5 og 3/4-16UNF)	
57W		WL7168	E75KD42	
58W		WL7168	E75KD42	
85W		WL7168	E75KD42	
86W		WL7168	E75KD42	
114W		WL7168	E75KD42	
115W		WL7168	E75KD42	
FK3	19	WL7079		
G/GS			E21K	
P10, R10, S10		WL7168	H100WK / E21K	
A30, K30, L30, P30, R30, S30	6-32	WL7168	H100WK / E21K	

FORD

MOTORTYPE	HK.	OLJE	DRIVSTOFF	LUFT
2401/ 4 Cyl.	54	E100H (Innsatsfilter, 95x95)	E75KD42	
2402/ 6 Cyl.	80	E119H (Innsatsfilter, 95x116)	E75KD42	
2514		H10W22	E75KD42	
2704/ 6 Cyl.	130	E119H (Innsatsfilter, 95x116)	E75KD42	
2704ET/ 6 Cyl.	150-180	E119H (Innsatsfilter, 95x116)	E75KD42	
2710 / 6 Cyl.	100	H17W02	E75KD42	
2712E / 4 Cyl. -1979	82-85	E100H (Innsatsfilter, 95x95)	E75KD42	
2712E/ 4 Cyl. 1980-	82-85	51087	E75KD42	
2715E/ 6 Cyl. -1979	120	E119H (Innsatsfilter, 95x116)	E75KD42	
2715E/ 6 Cyl. 1980-	120	51087	E75KD42	
2722/ 4 Cyl.	85	51087	E75KD42	
2725/ 6 Cyl.	126	51087	E75KD42	
2726T/ 6 Cyl.	155	51087	E75KD42	
2728TIM/ TI 6 Cyl.	200-350	H250WD01	E75KD42	

FORD-SABB

MOTORTYPE	HK.	OLJE	DRIVSTOFF	LUFT
F4.144/ 2401E	54	E100H (Innsatsfilter, 95x95)	E75KD42	
F4.254/ 2712E -1979	68	E100H (Innsatsfilter, 95x95)	E75KD42	
F4.254/ 2712E 1980-	68	51087	E75KD42	
F4.415/ 2722E	85	51087	E75KD42	
F6.216/ 2402E	80	E119H (Innsatsfilter, 95x116)	E75KD42	
F6.363T/ 2704E	130	E119H (Innsatsfilter, 95x116)	E75KD42	
F6.363Ti/ 2704ET	150-180	E119H (Innsatsfilter, 95x116)	E75KD42	
F6.380/ 2715E -1979	100	E119H (Innsatsfilter, 95x116)	E75KD42	
F6.380/ 2715E 1980-	100	51087	E75KD42	
F6.595/ 2726T	155	51087	E75KD42	
F6.595Ti/ 2728TI	200	H250WD01	E75KD42	
F6.595TIP/ 2728TIM	240	H250WD01	E75KD42	
F6.622/ 2725E	127	51087	E75KD42	

FORD USA

MOTORTYPE	MOD.	OLJE	DRIVSTOFF	LUFT
7.3L DIESEL	88 - 94	51742	33217	
7.3L DIESEL	95 - 98	51734	33517	
7.3L DIESEL	99 - 03	51734	33818	

FM

MOTORTYPE	HK.	OLJE	DRIVSTOFF	LUFT
Bensin	6-8	51184		
Bensin	8-12	51184		
Bensin	12-16	51184		

FNM MARINE

MOTORTYPE	HK.	OLJE	DRIVSTOFF	LUFT
HPE190	190	H14W29		
HPE225	225	MO-429		
HPE250	250	H14W29	H159WK	
HPE300	300	H19W12	H160WK	

GM

MOTORTYPE	HK.	OLJE	DRIVSTOFF	LUFT
4.3 Bensin (V6)		51036	33225/ 33231/ 33359	
5.7 Bensin		51060		
6.2 Diesel		51060	33136	
6.5 Diesel		51060	33376 (Innsats) 33124 (Spin on)	

HINO

MOTORTYPE	HK.	OLJE	DRIVSTOFF	LUFT
W04 CTA	150	836071490*(57014)	834011132/3*(33390)	
W04 CTI	210	57014 8038993T* (Nytt)	834011132/3*(33390)	
W06 DTI	250	57014 8038993T* (Nytt)	834011341*	
W06 DTA	310	57014 8038993T* (Nytt) 51050 (Olje bypass)	834011341*	

* Originalnr.

HONDA

MOTORTYPE	HK.	OLJE	DRIVSTOFF	LUFT
BF20	20	51358		
BF25	25	51358		
BF30	30	51358		
BF35	35	51358	MF-558	
BF40	40	51358	MF-558	
BF45	45	51358	MF-558	
BF50	50	51358	MF-558	
BF75	75	MO-511	MF-558	
BF90	90	MO-511	MF-558	
BF115	115	MO-511	WF8119 (Plast) (16010ST5993 Metall)*	
BF130	130	MO-511	WF8119 (Plast) (16010ST5993 Metall)*	
BF135	135	MO-511		
BF150	150	MO-511		
BF200	200	MO-511		
BF225	225	MO-511		

* Originalnr.

HYUNDAI se VETUS**IVECO**

MOTORTYPE	HK.	OLJE	DRIVSTOFF	LUFT
UNO M25.00		WL7324	H70WK02	
UNO M40.00		WL7324	H70WK02	
4000 Serie (Lombardini)	40	H90W13		
4000 Serie (Lombardini)	60	H90W13		
4000 Serie (Lombardini)	84	H90W13		
8031 M06.00		H208W01	H70WK02	
8031 M06.01		H208W01	H70WK02	
8035 M06		H208W01	H70WK02	
8041 M08.00		H208W01	E75KD42	
8041 M08.01		H208W01	E75KD42	
8041 M09.00		H208W01	E75KD42	
8041 M09.01		H208W01	E75KD42	
8041 SRM15.10		H210WN	H70WK02	
8045 M08	76	H210WN	H70WK02 / E75KD42	
8060 M12		H208W01	H70WK02	
8060 SM20		H210WN	H19WK02	
8060 SM21		H210WN	H19WK02	
8060 SRM 25		H210WN	H19WK02	
8061 M12.00		H208W01	E75KD42	
8061 M12.01		H208W01	E75KD42	
8061 M12.10		H208W01	E75KD42	
8061 M12.11		H208W01	E75KD42	
8061 M14.00		H208W01	H70WK02	
8061 M14.01		H208W01	H70WK02	
8061 M16.10		H220W	H19WK02	
8061 SM20.11		H210WN	H19WK02	
8061 SRM25.10		H210WN	H19WK02	
8061 SRM30.10		H210WN	H19WK02	
8061 SRM33.10		H210WN	H19WK02	
8065 M12	110	H208W01	H70WK02	
8141 M08.01		H210WN	H70WK02	
8141 M25.01		H210WN	H70WK02	
8141 SM12.01		H210WN	H70WK02	
8141 SRM13.01		H210WN	H70WK02	
8205		H220W	H19WK02	
8210 M12				

IVECO fortsetter

MOTORTYPE	HK.	OLJE	DRIVSTOFF	LUFT
8210 M22.10		H220W	H19WK02	
8210 SRM36	330			
8210 SRM45				
8220		H220W	H19WK02	
8280		H220W	H19WK02	
8280.22		H220W	H19WK02	
8281 M32.10		H220W	H19WK02	
8281 SRM44.10		H208W02	H19WK02	
8281 SRM70.11		H208W02	H19WK02	
8360		H220W	H19WK02	
8360 TURBO		H220WN	H19WK02	
8361 SM21.00		H220WN	H19WK02	
8361 SRM21		H220WN	H19WK02	
8361 SRM32.00		H220WN	H19WK02	
8361 SRM37.10		H220WN	H19WK02	
8460 SRM45.11		H220WN	H19WK02	
8460 SRM50.10		H220WN	H19WK02	
CURSOR M50 / F2BE / C78ENT	400-550	H230W	H152WK (Forfilter) H70WK09 (Hovedfilter)	
C87ENTM38.11		SO8088	5802037371*	
N40ENT M25	250	H19W10	33682	
N60ENT M37	365	H19W10	33682	
N67MNT M28	276	H19W10	33682	
NEF 100	99	H19W10	33682	
NEF 150	148	H19W10	33682	
NEF 250	250	H19W10	33682	
NEF 280	276	H19W10	33682	
NEF 370	365	H19W10	33682	
NEF 400	394	H19W10	33682	

DE FLESTE SABB / IVECO HAR FORFILTER = H70WK09

* Originalnr.

ISUZU

MOTORTYPE	HK.	OLJE	DRIVSTOFF	LUFT
3KCI	27	MO-429 (Spin on)	33262 (Innsats)	E565L
UM4BD1, T		51745 (Innsats) H17W01 (Spin on)	33259 (Innsats) NF-2252 (Spin on)	
UM6BD1, T		51282 (Innsats) H19W07 (Gj. 1"-12) 51798 (Gj. 1 1/8"-16)	IF 352 (Innsats) IF-3453 (Spin on) NF-2252 (Spin on)	
UMC240		51745 (Innsats) IO-332 (Gj. 20 x 15)		
UM4JB1		51094		
UM10PC I TK		51282 (Innsats)	IF3355	

JOHN DEERE / POWER TECH

MOTORTYPE	HK.	OLJE	DRIVSTOFF	LUFT
3029D, T	2,9L	H17W09		
4045D, H, T	4,5L	H17W09 / 57243	33756	
6068D, H, T	6,8L	57243	33756	
6068DFM	6,8L	57243		
6068SFM	6,8L	57750S	33756	
6068SFM50	6,8L	57750S	33975 (Sett med 2 filter)	
6068TFM	6,8L	57750S	33756	
6081A, H, T	8,1L	H215W		
6090		51370		
6135SFM75A	13,5L/575HK	H305W	33969 og 33979	
JD 300		H17W09	33548	
?			33975 (Sett med 2 filter)	

KHD

MOTORTYPE	HK.	OLJE	DRIVSTOFF	LUFT
BF3M1011		H11W03 / H14/2W*	H30WK01	
BF3M2011		H11W03 / H14/2W*	H70WK	
BF4M1011F (VETUS)	61	H11W03 / H14/2W*	H30WK01	46405
BF4M1012E	94	H17W04 / H18W01**	H60WK07	
BF4M1013M		H18W01	H60WK07	
BF4M2011		H11W03 / H14/2W*	H70WK	
BF4M2012E		H18W01	H60WK07	
BF6M1012E	117	H18W01	H60WK07	
BF6M1012EC	141	H18W01	H60WK07	
BF6M1013E	170	H18W01	H60WK07	ECB10-094****
BF6M1013EC	210	H18W01	H60WK07	ECB10-094****
BF6M1013M				B100094
BF6M1015MC		H200W	H701WK / H17WK10***	
BF6M2012E		H18W01	H60WK07	
BF6M2015MC		H200W	H701WK / H17WK10***	
BF8M1015MC		H200W	H701WK / H17WK10***	
BF8M2015MC		H200W	H701WK / H17WK10***	
F4M1011F	48	H14/2W	H30WK01	
F4M1012	78	H17W04 / H18W01**	H30WK01	
SBV6M628		E56H(1stk)		
SBV9M628		E56H(1stk)		
SBV16M628		E56H(4stk)		

* Kan være levert med forskjellige filter: H11W03 (H=59mm), H14/2W (H=76mm), H90W02 (H=93mm).

** Kan være levert med forskjellige filter: H17W04 (H=154mm), H18W01 (H=222mm).

*** Forfilter på drivstoff = H701WK.

**** Originalnr.

Noen motorer er levert med SEPAR filterhus SWK2000 med filter 01030 = E1030K.

Bokstavene i motornr. har ingen betydning for filter.

Vi lagerfører også til diverse andre motorer. Vennligst forespør.

KUBOTA Se NANNI-KUBOTA**LEYLAND**

MOTORTYPE	HK.	OLJE	DRIVSTOFF	LUFT
1,5L		51300	E75KD42	
1,8L -1978		WL7213	E75KD42	
1,8L 1979-		H10W01	E75KD42	
2,5L		WL7058	E75KD42	
3,8L		E119H	E75KD42	
5,7L		E119H	E75KD42	

LISTER - PETTER

MOTORTYPE	HK.	OLJE	DRIVSTOFF	LUFT
	55	H24W01	33192	

LISTER - SABB

MOTORTYPE	HK.	OLJE	DRIVSTOFF	LUFT
L3	30	H11W01	H30WK01	
L4	40	51335	H179WK	
LPW2	20		H179WK	
LPW3	30	H11W01	H179WK	

LPW4	40	H11W01	H179WK	
------	----	--------	--------	--

LOMBARDINI

MOTORTYPE	KW.	OLJE	DRIVSTOFF	LUFT
9LD 625.2		H90W02	H60WK01	
LDW 502M	8.5	H11W02	H30WK01	E160L
LDW 602M	10.3	H11W02	H30WK01	E160L
LDW 702M	13.2	H11W02	H30WK01	
LDW 903M	17.6	H11W02	H30WK01	E160L
LDW1003M	20.6	H11W02	H30WK01	
LDW1203		H14W29	H60WK07	
LDW1204		H90W13	H30WK01	
LDW1303		H14W29	H60WK07	
LDW1404M	27.2	H90W13	H30WK01	
LDW1503M	24.6	H90W25	H30WK01	
LDW2004M	33.1	H90W25	H60WK07	
LDW2004MT	55.1	H90W13	H60WK07	
LDW2204M	60HK	H90W25	H60WK07	
LDW2204MT	85HK	H90W13	H60WK07	

MARINER

MOTORTYPE	HK.	OLJE	DRIVSTOFF	LUFT
	9,9 (4-TAKT)	MO-511	*	
	15 (4-TAKT)	MO-511	*	
	25 (2-TAKT)	51085	*	
	25 (4-TAKT)	MO-511	*	
	30 (2-TAKT)	51085	*	
	30 (4-TAKT)	MO-511	*	
	40 (4-TAKT)	MO-511	*	
	50 (4-TAKT)	MO-511	*	
	60 (4-TAKT)	MO-511	*	
	75 (4-TAKT)	MO-511 / 51358**	*	
	90 (4-TAKT)	MO-511 / 51358**	*	
	115 (4-TAKT)	MO-511 / 51358**	*	
	125 (4-TAKT)	MO-511	*	
100HK EFI 2006	100HK	WL10069		

* Slangefilter kan være 33002 (8mm.) eller 33003 (10mm.) "SPIN ON" kan være 33225

Det kan være andre avhengig av årsmodell. Oppgi originalnr. hvis mulig.

** MO-511 opp til motornr.. 1B366872 / 51358 fra motornr. 1B366823

***Originalnr.

MAN

MOTORTYPE		OLJE	DRIVSTOFF	LUFT
D2866LX		E174HD11		

MARNA

MOTORTYPE		OLJE	DRIVSTOFF	LUFT
L2		51188	E2KP	
MB 10A		H11W01		
M	-1965		33114	
M1	-1965	E110MD02		
M1		51183	E75KD42	
M2		E110MD02		
M2, M3, M4	1965-	E134HD06	E75KD42	
ML 2		51188	E75KD42	

MERCEDES

MOTORTYPE		OLJE	DRIVSTOFF	LUFT
OM615, 616, 617	-1976 1976-	E110MD02 E196HND03	E5KFR2D12/H31WK01 E5KFR2D12/H31WK01	
OM621		E110MD02	E5KFR2D12	
OM636			E5KFR2D12	

Angående andre motornr. Vennligst forespør.

MERCUISER

MOTORTYPE	HK. / L	OLJE	DRIVSTOFF	LUFT
25, 30, 55, 60, 80		H10W01		
90		H11W01		
110, 120	V8	57099	33034	
130, 140, 150, 160, 165, 170, 180	V8	51060 (96x130) 57099 (93 X 85)	33050	
188		H10W01 (95 mm.) H17W02 (140mm.)		
190, 196, 198, 200		51060 (96x130) 57099 (93 X 85)		
320EFI		57099		
898		51060		
FORD:		H10W01 (95 mm.)		
215, 225, 233, 236, 255, 555, 888		H17W02 (140mm.)		
235		H17W02		
GM:				
175	175Hk./4,3L	51036	35-803897Q1*(Sil)	
185 83-87	185Hk./4,3L	51036	35-803897Q1*(Sil)	
205 85-87	205Hk./4,3L	51036	35-803897Q1*(Sil)	
262	4,3L	57099	33225 13/16" - 16	
225, 228, 230, 250, 255, 260 270, 280, 300, 310, 325, 330, 340, 350, 355, 365 370, 390, 400, 420, 454 470, 474, 485, 525, 575 330TR, 330TRS, 420TRS		51060 (96x130) 57099 (93 X 85)		
CMD 2.8L	165Hk.	51754	33546	
CMD 2.8L	170Hk.	E1001HD28	33546	
CMD 2.8L	200Hk.	E1001HD28	33546	
D183 3,0L t.o.m. s.nr:OD725459	5 Syl./ 140Hk	H19W04/51754	WF8060	E037L01
D183 3,0L f.o.m. s.nr:OD725460	5 Syl./ 140 Hk	51754	33546	805311*
D190		51754		
D219 3,6L t.o.m. s.nr:OF306929	6 Syl./ 170 Hk	H19W04	WF8060	E037L01
D219 3,6L f.o.m. s.nr:OF306930	6 Syl./ 170 Hk	51754	33546	805311*
D219 Turbo	180 (VM)	H19W04	WF8060	E037L01
D254	220 (VM)	H19W04	WF8060	E037L01
D 1,7 L DTI	116 Hk	E22HD88	IF-353	
D 2,8 L200		E1001HD28	H160WK	
D 3,0L 1995	5 Syl./150Hk	H19W04	WF8060	
D 3,6L T.O.M S.NR. D725459/ F306929		51459		
D 3,6L F.O.M S.NR. D725460/ F306930	180 Hk/ VM 219	51754	33546	
D 4,2L t.o.m. s.nr:OF450249	6 Syl./ 210 Hk.	H19W04	WF8060	E037L01
D 4,2L f.o.m. s.nr:OF450250	6 Syl./ 210 Hk.	51754	33546	805312*
D 4,2L	6Syl./ 300Hk.	51754	33546	
D 7,3L	V8	51742	33217 H:102mm / 33231 H:130mm.	808289*
D 7,3L D-tronic	V8	51742	33546	
MCM502 8.2L	380Hk.	57099		
MX 6,2 MPI	320	57099	33225 13/16" - 16	
QSD 2.0L-115 / 4Syl. -09**	115Hk.	DO-711	H160WK	
QSD 2.0L-130 / 4Syl. -09**	130Hk.	DO-711	H160WK	
QSD 2.0L-150 / 4Syl. -09**	150Hk.	DO-711	H160WK	
QSD 2.0L-170 / 4Syl. -09**	170Hk.	DO-711	H160WK	
QSD 2.8L-170 / 4Syl. 07-	170Hk.	E1001HD28	H160WK	
QSD 2.8L-210 / 4Syl. 07-	210Hk.	E1001HD28	H160WK	
QSD 2.8L-220 / 4Syl. 07-	220Hk.	E1001HD28	H160WK	
QSD 2.8L-230 / 4Syl. 07-	230Hk.	E1001HD28	H160WK	
QSD 4.2L-270 / 6Syl.07-	270Hk.	E1001HD28	H160WK	
QSD 4.2L-320 / 6Syl.07-	320Hk.	E1001HD28	H160WK	
QSD 4.2L-350 / 6Syl.07-	350Hk.	E1001HD28	H160WK	11132047*

Eldre motorer med filter i blokk bruker 51036 (Gj. 18x1,5)

Nyere motorer (ca.92-) med filter adapter bruker 57099 (Gj. 13/16"-16)

Drivstoff filter for div. motorer m/bajonett feste = H203WK

*Originalnr.

**Nyere enn 2010

E1001H028

MERCUISER Forts.

MOTORTYPE	HK. / L	OLJE	DRIVSTOFF	LUFT
QSB 5.9L-380 / 6Syl.	380Hk.	H19W08	33697	
QSB 5.9L-425 / 6Syl.	425Hk.	H19W08	33697	
QSB 5.9L-480 / 6Syl.	480Hk.	H19W08	33697	
V6 EFI 06-			WF10161	
2,8ES 170 / 2,8ES 200	2.8l	E1001HD28	33546	
3,0L ALPHA L/ LX		57099	33225 13/16" - 16	
4,0MPI		57099	33225 13/16" - 16	
4,2ES 320	4,2L		33546	
4,3L/LX 88-92	4,3L	51036	35-803897Q1*(Sil)	
4,3L/LX 92-93	4,3L	57099	33225 13/16" - 16	
4,3L/LX 93-98	4,3L	57099	33225 13/16" - 16	
4,3LH 98	4,3L	57099	33225 13/16" - 16	
4,3LXH 96-97	4,3L	57099	33225 13/16" - 16	
4,3EFI	4,3L	57099	33225 13/16" - 16	
4,3MPI	220Hk./4,3L	57099	33225 13/16" - 16	
5,0L ALPHA L/ LX 305CI		57099	33225 13/16" - 16	
5,0L EFI		57099	33225 13/16" - 16	
5,0MPI		57099	33225 13/16" - 16	
5,7L ALPHA L 350CI		57099	33225 13/16" - 16	
8,1			33225 13/16" - 16	
8,2	380Hk/8,2L	57099		
350 MAGNUM	5,7L	57099	33225 13/16" - 16	
454 MAGNUM	7,4L	57099	33225 13/16" - 16	
496 MAGNUM			33225 13/16" - 16	
502 MAGNUM	8,2L	57099	33225 13/16" - 16	

Eldre motorer med filter i blokk bruker 51036 (Gj. 18x1,5)

Nyere motorer (ca.92-) med filter adapter bruker 57099 (Gj. 13/16"-16)

Drivstoff filter for div. motorer m/bajonett feste = H203WK

*Originalnr.

MERCURY

MOTORTYPE	HK.	OLJE	DRIVSTOFF	LUFT
9,9 (4-TAKT)		MO-511	*	
15 (4-TAKT)		MO-511	*	
20 (4-TAKT)	2008-	51358	*	
25 (4-TAKT)		MO-511	*	
30 (4-TAKT)		MO-511	*	
30 (4-TAKT)	2006-	51358	*	
40 (4-TAKT)		MO-511	*	
50 (4-TAKT)		MO-511	*	
60 (4-TAKT)		MO-511	*	
75 (4-TAKT)		MO-511 / 51358**	*	
75 (4-TAKT)	2007-	WL10069	*	
80 (4-TAKT)	2007-	WL10069	*	
90 (4-TAKT)		MO-511 / 51358**	*	
90 (4-TAKT)	2007-	WL10069	*	
100 (4-TAKT)		51358	*	
100 (4-TAKT)	2007-	WL10069	*	
115 (4-TAKT)		MO-511 / 51358**	*	
115 (4-TAKT)	2007-	WL10069	*	
125 (4-TAKT)		MO-511	*	
150 (4-TAKT)	2009-	WL10069	*	
150 VERADO	2015	35-877767-001		

* Slangefilter kan være 33002 (8mm.) eller 33003 (10mm.) "SPIN ON" kan være 33225

Det kan være andre avhengig av årsmodell. Oppgi originalnr. hvis mulig.

** MO-511 opp til motornr.. 1B366872 / 51358 fra motornr. 1B366823

MITSUBISHI se VETUS**MITSUBISHI-SABB**

MOTORTYPE	HK.	OLJE	DRIVSTOFF	LUFT
?	20	HO-823		
M4.130/ K4D	30	HO-823	H60WK01	
M4.140/ K4D	33	HO-823	H60WK01	
M4.210/ 4DQ5 (Yrkesbåt)	45	51261	33394	
M4.210/ 4DQ5 (Lystbåt)	50	51261	33394	
M4.295/ S4E2 (Yrkesbåt)	65	51261	33394	
M4.295/ S4E2 (Lystbåt)	70	51261	33394	

M4.295 TURBO/S4E2 TURBO / S6E2	90	51261 NO-228		
-----------------------------------	----	-----------------	--	--

MWM: Vennligst forespør**NANNI**

MOTORTYPE	HK.	OLJE	DRIVSTOFF	LUFT
2.45 ECO (2 Syl) KUBOTA	10	FO-011A	DF-7751	
2.50 HE (2 Syl) KUBOTA	14	FO-011A	H31WK01	
3.75 HE (3 Syl) KUBOTA	21	FO-011A	H31WK01	
3.100 HE (3 Syl) KUBOTA	29	MO-523	DF-7751	
3.110 HE (3 Syl) KUBOTA	27	MO-523	H31WK01	
4.110 HE (4 Syl) KUBOTA	38	H90W04	H31WK01	
4.150 HE (4 Syl) KUBOTA	37	MO-523	H31WK01	
4.180 HE (4 Syl) KUBOTA		51085	E5KPD12	
4.190 HE (4 Syl) KUBOTA	43	51085	H31WK01	
4.195 HE (4 Syl) KUBOTA	40	51085	H31WK01	
4.200 HE (4 Syl) KUBOTA	42	51085	H31WK01	
4.200 TDI (4Syl) KUBOTA	60	51085	DF-7751	
4.220 HE (4 Syl) KUBOTA	50	51085	H31WK01	
4.330 TDI (4 Syl) KUBOTA	115	51085	IF-3356	
4.340 TDI (4 Syl) KUBOTA	130	51085	IF-3356	
4.380 TDI TOYOTA	175	TO-140	TF-1652	
4.390 TDI TOYOTA	200	TO-140	TF-1652	
4.440 E MAN	100	SO040	H70WDK14	
4.440E-SC MAN	112	H17W04	H70WDK14	
5.250 TDI (5 Syl) KUBOTA	85	51085	DF-7751	
5.280 HE (5 Syl) KUBOTA	62	51085	H31WK01	
6.280 HE (6 Syl) KUBOTA	60	51085	H31WK01	
6.420 TDI TOYOTA	320	TO-140	TF-1652	
6.660 E MAN	150	SO040	H70WDK14	
6.660 LE MAN	309	SO040	H70WDK14	
N2.10 KUBOTA	10	FO-011A	48100919*	
N2.14 KUBOTA	14	FO-011A	H31WK01	
N3.21 KUBOTA	21	FO-011A	H31WK01	
N3.30 KUBOTA	29	MO-523	H31WK01	
N4.38 KUBOTA	37,5	MO-523	H31WK01	
N4.40 KUBOTA	40	51085	H31WK01	
N4.43 KUBOTA	43	51085	H31WK01	
N4.50 KUBOTA	50	51085	H31WK01	
N4.60 KUBOTA	60	51085	DF-7751	
N4.85 KUBOTA	85	KO-5001	NF-2252	
N4.100 KUBOTA	100	KO-5001	NF-2252	
N4.115 KUBOTA	115	51085	NF-2252	
QLS 2,2T KUBOTA	24	KO-5001	H31WK01	
T4.155 TOYOTA	155	TO-140	TF-1652	
T4.270 TOYOTA	265	57730	TF-1652	
T6.300 TOYOTA	308	TO-140	TF-1652	

*Originalnr..

OMC

MOTORTYPE	HK.	OLJE	DRIVSTOFF	LUFT
100, 110, 120, 130		57099		
140		57099		
150, 155		51258		
165		51060 (96x130)		
170, 175, 190	Ford V8	51036		
185	Chevrolet V8	51060 (96x130)		
200	Buick V8	51183 51258		
200	Chevrolet	57099		
205, 229	Chevrolet V6	51036		
210, 215, 225, 230, 235, 245		51060 (96x130)		
235	Ford	H17W02		
250, 260		57099 (93 X 85)		
262 4,3L. 6 Cyl.		51036		
2,3L. Cobra 4 Cyl.		H17W02	33364	
2,5L. Cobra 4 Cyl.		57099		
3,0L. Cobra 4 Cyl.		H17W02	33364 gj.1"-12 H:110, D:93	

OMC Forts.

MOTORTYPE	HK.	OLJE	DRIVSTOFF	LUFT
3,0L. Cobra EFI		MO-511	33247* gj.13/16" H:86, D:74	
4,3L. Cobra 6 Cyl.		51036	33364	
4,3L. Cobra EFI			33247*	
5,0L. Cobra EFI		MO-511	33247*	
5,0L./ 5,7L. Cobra 8 Cyl.		51060 (96x130)	33364	
5,8L. Cobra EFI			33247*	
7,4L. Cobra EFI			33247*	
7,5L. Cobra		H17W02		
8,2L. Cobra EFI			33247*	

* Passer på de fleste modeller.

PERKINS

MOTORTYPE	HK.	OLJE	DRIVSTOFF	LUFT
1100		H17W06 (Skru, H=139mm.)		
3.144M, E110MD02.144M		51188	E75KD42 (Innsatsfi. 87x72) 33194 (Innsatsfi. 73x83)	
3.152M, E110MD02.152M -73		51188	E75KD42 (Innsatsfi. 87x72) 33194 (Innsatsfi. 73x83)	
3.152M, E110MD02.152M 73-		H14W03	E75KD42 (Innsatsfi. 87x72) 33194 (Innsatsfi. 73x83)	
4.107M		51188 (73x114mm.) E100H (Innsatsfilter, 95x95)	E75KD42 (Innsatsfi. 87x72) 33194 (Innsatsfi. 73x83)	
4.108M	49	E100H (Innsatsfilter, 95x95) H17W06 (Skru, H=139mm.) H19W04 (Skru, H=165mm.)	E75KD42	
4.236M, LL	60/ 72/ 81	51188 (Innsatsfilter, 73x114) E119H (Innsatsfilter, 95x116) H17W06 (Skru, H=139mm.) H19W04 (Skru, H=165mm.)	E75KD42 (Innsatsfi. 87x72) 33194 (Innsatsfi. 73x83)	
4.270M		E119H (Innsatsfilter, 95x116)	E75KD42 (Innsatsfi. 87x72) 33194 (Innsatsfi. 73x83)	
6.305M		E119H (Innsatsfilter, 95x116)	E75KD42 (Innsatsfi. 87x72) 33194 (Innsatsfi. 73x83)	
6.354M, LL	90/ 115	E100H (Innsatsfilter, 95x95) E119H (Innsatsfilter, 95x116) H17W06 (Skru, H=139mm.) H19W04 (Skru, H=165mm.)	E75KD42	
6.354 4M	110/ 115	E100H (Innsatsfilter, 95x95) E119H (Innsatsfilter, 95x116) H17W06 (Skru, H=139mm.) H19W04 (Skru, H=165mm.)	E75KD42	
HT 6.354M	145/ 175	E100H (Innsatsfilter, 95x95) E119H (Innsatsfilter, 95x116) H17W06 (Skru, H=139mm.) H19W04 (Skru, H=165mm.)	E75KD42	
T 6.354M	115/ 145	E100H (Innsatsfilter, 95x95) E119H (Innsatsfilter, 95x116) H17W06 (Skru, H=139mm.) H19W04 (Skru, H=165mm.)	E75KD42	
T 6.354 4M	185/ 220/ 275	E100H (Innsatsfilter, 95x95) E119H (Innsatsfilter, 95x116) H17W06 (Skru, H=139mm.) H19W04 (Skru, H=165mm.)	E75KD42	
V 8.510M		E100H (Innsatsfilter, 95x95) E119H (Innsatsfilter, 95x116) H17W06 (Skru, H=139mm.) H19W04 (Skru, H=165mm.)	E75KD42	

NB! Det kan sitte forskjellige filter, se parantes for å finne det korrekte filter til din motor.

PERKINS SABRE

MOTORTYPE	HK.	OLJE	DRIVSTOFF	LUFT
M65	60	H24W03	E75KD42	
M85T	76	H24W03	E75KD42	
M90	81	H17W06	E75KD42	
M92	82	H17W06	H70WK02	
M115T	102	H17W06	H70WK02	
M130C	127	H17W06 x 2	E75KD42 x 2	
M135	133	H17W06 x 2	E75KD42 x 2	
M185C	182	H17W06 x 2	E75KD42 x 2	
M215C	202	H17W06 x 2	E75KD42 x 2	
M225TI	222	H17W06 x 2	E75KD42 x 2	
M250C			WF10000	
M265TI	242	H17W06 x 2	H60WK01	
M300TI	278	H17W06 x 2	H60WK01	
M600C	709			

PEUGEOT se VETUS**RUGGERINI**

MOTORTYPE	HK.	OLJE	DRIVSTOFF	LUFT
RD180		H11W01	H60WK01	
RD200		H11W01	H60WK01	
RD210		H11W01	H60WK01	
RDM901, 902		H11W01		
RP368	20	H14W04	H30WK01	

SABB

MOTORTYPE	HK.	OLJE	DRIVSTOFF	LUFT
G, GA, GAG, GG	8 - 10	H10W01	E2KP	
H, HG	18	H10W01	E2KP (Innsatsfilter) H30WK01 (Skrufilter)	
2G, 2GRG	16 - 22	E110M D02 (Innsatsfilter) H10W01 (Skrufilter)	E2KP	
2H, 2HG	18	H10W01	E2KP (Innsatsfilter) H30WK01 (Skrufilter)	
2J, 2JGR	30	H10W01	E2KP (Innsatsfilter) H30WK01 (Skrufilter)	

NB! Det kan sitte forskjellige filter, se parantes for å finne det korrekte filter til din motor.

SCANIA

MOTORTYPE	HK.	OLJE	DRIVSTOFF	LUFT
9.93 (01/99-)			H70WK	E218L
9.95 (01/99-)			H70WK	E218L
D16M				49011
DI9 (01/99-)			H60WK08	E218L
DI12 (01/99-)		H200W40	H60WK08	E290L/49011
DI14 (01/99-12/01)		H200W40	H60WK08	E290L
DI16M (01/02-)	V8	E21HD74	E57KPD73	
DN11.01 (01/81-12/90)			H70WK	E283L
DN11.40-43M (01/89-)			H70WK	E283L
DS9M (01/90-12/98)			H70WK	E218L
DS11M (04/81-12/98)			H70WK	E218L/49011
DSI11M (01/72-12/98)			H70WK	E218L/E290L/49011
DSI14M (01/72-12/98)			H70WK	E218L/E290L/49011

SELVA

MOTORTYPE	HK.	OLJE	DRIVSTOFF	LUFT
9,9	9,9	51358	*	
25	25	51358	*	
40	40	51358	*	
50	50	51358	*	
60	60	51358	*	
80	80	51358	*	
100	100	51358	*	
115	115	51358	*	

* Slangefilter kan være 33002 (8mm) ellr 33003 (10mm)

SISU DIESEL

MOTORTYPE	KW	OLJE	DRIVSTOFF	LUFT
84 CTIM		MH3334	WF10159 / 33761 (2 stk. på motor)	
320 DM		H40W02	E75KD42	
320 DSM		H40W02	E75KD42	
411 CM		MH3311		
420 DM u/turbo	63	H40W02	E75KD42	
420 DSM m/turbo	96 - 103	H40W02	E75KD42	
420 DSIM	110 - 125			
612DSM, DSBM, DSIM	218	MH3334	H60WK07	
620 DM u/turbo	96	H40W02	E75KD42	
620 DSM m/turbo	140 - 154	H40W02	E75KD42	
620 DSBM	154 - 173			
620 DSBIM	184 - 220			
645 DSBIM	206 - 300			

*Originalnr..

SOLE DIESEL

MOTORTYPE	HK.	OLJE	DRIVSTOFF	LUFT
Mini - 10 (Mi. K2AS)	9	MO-429 (Dia. 83mm)*		
Mini - 11 (Mi. L2A)	11	MO-429 (Dia. 83mm)*		
Mini - 14 (Mi. K2C)	13	MO-429 (Dia. 83mm)*		
Mini - 17 (Mi. L2E)	16	FO-011A (Dia. 72mm)	131.14.022**	
Mini - 18 (KE75)	17			
Mini - 23 (Mi. K3D)	20	MO-429 (Dia. 83mm)*		
Mini - 26 (Mi. L3E)	25	MO-429 (Dia. 83mm)*	131.14.022**	
Mini - 28 (Lombardini)	21KW	H14W04	H60WK07	
Mini - 29		MO-429 (Dia. 83mm)*		
Mini - 32 (Mi. K4C)	28			
Mini - 33 (Mi. S3L2)	32	MO-429 (Dia. 83mm)*		
Mini - 34 (Mi. K4D)	31	MO-429 (Dia. 83mm)*		
Mini - 44 (Mi. S4L2)	42	MO-429 (Dia. 83mm)*		
Mini - 48 (Mi.)	45	MO-431		
Mini - 50 (Seat 1,7)	50	WL7324	E75KD42	
Mini - 62 (Mi. S4Q)	60	H90W13		
Mini - 74	72	CO-6002		
HS - 121 (Hino WO4D)	115	51796	DF-7751	
HS - 150 (Hino WO4C-T)	145	51796	DF-7751	
SM - 120 (Mi. S6E)	122	NO-225	33394 (Spin on) YF-9107 (Innsats)	
SM - 615 (M.B. OM615)	40KW.	E196HN D03	E5KFR2D12	
SM - 616 (M.B. OM616)	72	E196HN D03	H31WK01	
SM - 636 (M.B. OM636)	31KW.		E5KFR2D12	

* MO-429 kan ha for stor diameter, kan da bruke MO 526 (dia. 71mm.)

**Originalnr.

STEYR

MOTORTYPE	KW.	OLJE	DRIVSTOFF	LUFT
94	63	H17W18	H60WK07	
104	70	H17W18	H60WK07	
114	81	H17W18	H60WK07	
126	90	H17W18	H17WK02	
144, 144VTI	106	H17W18	H60WK07	2177468/0*
164	120	H17W18	H60WK07	2178992/0*
166	120	H17W18	H17WK02	2178992/0*
174	122	H17W18	H60WK07	2178992/0*
236	156	H17W18	H17WK02	2178992/0*
246	176	H17W18	H17WK02	2178992/0*
256 (-68226999)	183	H17W18	H17WK02	2178992/1 eller 2178992/0*
256 (68227001-)	183	2179472/0*	H17WK02	2178992/1 eller 2178992/0*
266	191	H17W18	H17WK02	2178992/0*
286	201	2179852/0* (2 STK.)	2179992/0*	Z002100/4*

H17WK02 (280l.pr.t) og H60WK07 (160l.pr.t) kan brukes om hverandre.

* Originalnr.

SUZUKI

MOTORTYPE	HK.	OLJE	DRIVSTOFF	LUFT
DF8A		16510-05240***		
DF9,9 1996-2010		16510-05240***		
DF9,9A		16510-05240***		
DF9,9T/HT 2011-		16510-45H10***		
DF15 1996-2010		16510-05240***		
DF15 2011-		16510-45H10***		
DF25	25	51360**	*	
DF25V-TWIN	25	51360**		
DF30	30	51360**	*	
DF40	40	51360**	*	
DF40A	40	57890		
DF50	50	51360**	*	
DF50A	50	57890		
DF60	60	51360**	*	
DF60A	60	57890		
DF70	70	51360**	*	
DF70A 2009-2010	70	SO-915		
DF70A 2011-	70	SO-922		
DF80A 2009-2010	80	SO-915		
DF80A 2011-	80	SO-922		
DF90	90	SO-915	*	
DF90A 2009-2010	90	SO-915		
DF90A 2011-	90	SO-922		
DF115	115	SO-915	*	
DF140	140	51360	*	
DF150	150	SO-915	*	
DF175	175	SO-915	*	
DF200	200	SO-915	*	
DF225	225	SO-915	*	
DF250	250	SO-915	*	
DF300	300	SO-915		

* Slangefilter kan være 33002 (8mm) eller33003 (10mm).

** 51360 (76mm) kan være for langt, bruk 57890 (53,6mm)

Nyere DF25/30/40/50/60/70 = 57890

*** Originalnr.

THORNYCROFT

MOTORTYPE	HK.	OLJE	DRIVSTOFF	LUFT
80 1.415l	33			
154		WL7058		

TOHATSU

MOTORTYPE	HK.	OLJE	DRIVSTOFF	LUFT
9,9	9,9	51358		
15	15	51358		
18	18	51358		
25	25	51358		
30	30	51358		

VALMET se SISU**VETUS**

MOTORTYPE	HK.	OLJE	DRIVSTOFF	LUFT
D4.29 (Deutz)	65	H11W03 / H90W02**	H30WK01	46405
DT4.29 (Deutz)	83	H11W03 / H90W02**	H30WK01	46405
DT43 (Deutz)	106	H17W04	H60WK07	
DTA43 (Deutz)	128	H17W04	H60WK07	
DT44 (Deutz)	114	H17W04	H60WK01	
DTA44 (Deutz)	140	H17W04	H60WK01	
DT64 (Deutz)	159	H18W01	H60WK07	
DTA64 (Deutz)	192	H18W01	H60WK07	
DT66 (Deutz)	170	H18W01	H60WK01	
DTA66 (Deutz)	210	H18W01	H60WK01	
DT67 (Deutz)	231		H60WK07	ECB10-0094*
DTA67 (Deutz)	286		H60WK07	ECB10-0094*
M2.04 (Mitsubishi)	8	MO-511	33192	
M2.05 (Mitsubishi)	13	MO-511	33192	
M2.06 (Mitsubishi)	16	MO-511	33192	
M2.C5 (Mitsubishi)	11	MO-511	33192	
M2.D5 (Mitsubishi)	13	MO-511	33192	
M2.D6 (Mitsubishi)	16	MO-511	33192	
M3.09 (Mitsubishi)	25	MO-511	33192	
M3.28 (Mitsubishi)	27	MO-511	33192	
M3.10 (Mitsubishi)	22	MO-511	33192	
M4.14 (Mitsubishi)	33	MO-511	33192	
M4.15 (Mitsubishi)	33	MO-511	33192	
M4.17 (Mitsubishi)	42	MO-511	33192	
M4.55 (Mitsubishi)	52	MO-511	33192	
P4.17 (Peugeot)	31		33192	
P4.19 (Peugeot)	51	H11W02	33192	
P4.25 (Peugeot)	45		33192	
P4.42 (Peugeot)	57	H11W02	33192	
VH 4.65 (Hyundai)	65,3	MO-400	33192	
VH 4.80 (Hyundai)	80,3	MO-400	33192	

* Originalnr.

** Kan være levert med forskjellige filter: H11W03 (H=59mm) eller H90W02 (H=93mm)

Noen kan også ha drivstoffilter E75KD42 (Innsats)

VM

MOTORTYPE	HK.	OLJE	DRIVSTOFF	LUFT
HR 494, H, HT, SHIR, HPT	2,8L	H17W06	H70WK02/E75KD42	
HR 692	3,6L	H19W04	E76KD42/ E75KD42	
HR 694, H, HT	4,2L	H19W04	E76KD42/ E75KD42	
	180HK	51754	WF8060	

VOLVO PENTA

MOTORTYPE	HK.	OLJE	DRIVSTOFF	LUFT
2001/B, 2002/B, 2003/B/T/TB		H11W01	E75KD42 (Forfilter/ Innsats) H30WK01 (Spin on)	
AD31/ A/ B/ D/ XD/ P/ L-A/P-A		H10W22	H60WK07 (Spin on) *	42473
AD41A/ B/ D/ P/ L-A/P-A		51596	H60WK07 (Spin on) *	42473
AQ60/F, 90. 95/A, 100, 105, 110 115/ A/ B, 120/B , 125A/ B 130 A/B/C/D, 131 A/B/C/D, 140 140A, 145 A/ B, 151 A/ B/ C, 165A, 170 A/ B/ C, 171 A/ C, 230 A/ B, 250 A/ B, 251A		H10W22	E75KD42 (Innsatsfilter)	
AQ175		51036	E75KD42 (Innsatsfilter)	
AQ190/ A		H17W02	E75KD42 (Innsatsfilter)	
AQ200		H17W02	E75KD42 (Innsatsfilter) 33225 (Spin on)	
AQ200A/ B/ C/ D/ E/ F		57099	E75KD42 (Innsatsfilter) 33225 (Spin on)	
AQ205		51036	E75KD42 (Innsatsfilter) 33225 (Spin on)	
AQ211A		57099	E75KD42 (Innsatsfilter) 33225 (Spin on)	
AQ225B/ C/ D/ E/ F		57099	E75KD42 (Innsatsfilter) 33225 (Spin on)	
AQ231A/ B		57099	E75KD42 (Innsats) 33225 (Spin on)	
AQ240A		H17W02	E75KD42 (Innsatsfilter)	
AQ255A/ B		57099	E75KD42 (Innsatsfilter)	
AQ260A/ B		57099	E75KD42 (Innsatsfilter)	
AQ271A/ B/ C/ D		57099	E75KD42 (Innsats) 33225 (Spin on)	
AQ280A		57099	E75KD42 (Innsatsfilter)	
AQ290A		57099	E75KD42 (Innsatsfilter)	
AQ311A/ B		57099	E75KD42 (Innsats) 33225 (Spin on)	
AQAD30 A		H10W22	E75KD42 (Forfilter/ Innsats) ** H60WK07 (Spin on) *	WA6229
AQAD31A		H10W22	E75KD42 (Forfilter/ Innsats) ** H60WK07 (Spin on) *	42473
AQAD40 A/B		51596	E75KD42 (Forfilter/ Innsats) ** H60WK07 (Spin on) *	WA6229
AQAD41 A		51596	E75KD42 (Forfilter/ Innsats) ** H60WK07 (Spin on) *	42473
AQD2 B		H11W01	E2KP	
AQD21 A/ B, 29	Snr.-103386 Snr.103387-	51036 (Genger 18 x 1,5mm) H90W03 (Gjenger 18 x 1.5mm)	E75KD42 (Innsats)	42473 ***
AQD32 A		H90W03	E75KD42 (Innsatsfilter)	
AQD40 A/ B		51596	E75KD42 (Forfilter/ Innsats) ** H60WK07 (Spin on) *	WA6229
AQD40C		51596	E75KD42 (Forfilter/ Innsats) ** H60WK07 (Spin on) *	WA6229
AQD41A		51596	E75KD42 (Forfilter/ Innsats) ** H60WK07 (Spin on) *	42473
AQD70B/ C		H19W05	H60WK07 (Spin on) **	46670
AQD70BL/ CL		H19W05	H60WK07 (Spin on) **	46670

* Her kan man også bruke H70WK02 med tapping.

** E75KD42 (87x72mm.), kan også være E76K D42 (87x112).

*** Passer de fleste modeller.

Rundt luftfilter Ø 206MM = 42473

Rundt luftfilter Ø 155MM = SA6092

VOLVO PENTA Forts.

MOTORTYPE	HK.	OLJE	DRIVSTOFF	LUFT
AQD70D		51596	H60WK07 (Spin on) **	46670
BB30		H10W22	E75KD42 (Innsatsfilter)	
BB100		H10W22	E75KD42 (Innsatsfilter)	
BB115 A/B/C		H10W22	E75KD42 (Innsatsfilter)	
BB140A		H10W22	E75KD42 (Innsatsfilter)	
BB145A		H10W22	E75KD42 (Innsatsfilter)	
BB165A		H10W22	E75KD42 (Innsatsfilter)	
BB170 A/ B/ C		H10W22	E75KD42 (Innsatsfilter)	
BB225 A/ B/ C		57099	E75KD42 (Innsats) 33225 (Spin on)	
BB231A		57099	E75KD42 (Innsats) 33225 (Spin on)	
BB260A/ B/ C		57099	E75KD42 (Innsatsfilter)	
BB261A		57099	E75KD42 (Innsats) 33225 (Spin on)	
D1-13 A, B, D, F		MH3350	NF-2252	
D1-20 A, B, F		MH3350	NF-2252	
D1-30 A, B, F		MH3373		
D2-40 A, B, F		MH3373	33393	
D2-55		MH3373	33393	
D2-75		MH3373	33393	
D3 -2009		E27HD84	H193WK	SA6092
D3 2010-		E417HD125	21139810*	21171277*
D4		MH3418 / MH3419 (BYPASS)	SN30039	SA6122
D6		MH3418 / MH3419 (BYPASS)	SN30039	SA6122
D7A-B TA		2xH200W	2xH34WK	20483100*
D9		2 x H200W40 (FULL FLOW) 1 x H200WN0101 (BYPASS)	H7120WK10 / Racor: 33798 Kan være: 3809721* / 3888460*	SA6122 (Flate)
D11		2 x H200W40 (FULL FLOW) 1 x H200WN0101 (BYPASS)	H7120WK10 / Racor: 33798 Kan være: 3809721* / 3888460*	21496510* (Runde) eller 21702999* (Flate)
D12		2 x H200W40 (FULL FLOW) 1 x H200WN0101 (BYPASS)	H7120WK10 / Racor: 33798 Kan være: 3809721* / 3888460*	21196919*= 3885441*= 3828811* (Runde)
D13		2 x H200W40 (FULL FLOW) 1 x H200WN0101 (BYPASS)	H7120WK10 / Racor: 33798 Kan være: 3809721* / 3888460*	21196919*= 3885441*= 3828811* (Runde)
D41 A/ B/ D/ L-A		51596	H60WK07 (Spin on) **	42473
KAD32 P-A		H10W22	H60WK01	WA6229
KAD40		51596	H60WK07 (Spin on) **	WA6229
KAD41		51596 / H19W05****	H60WK07 (Spin on) **	42473
KAD42A/ B/ P-A		51596 / H19W05****	H70WK02	WA6229
KAD43 P-A		51596 / H19W05****	H70WK02	WA6229
KAD44 A/ B/ C/ P-A/ P-B/ P-C		H19W05	H70WDK15	WA6229
KAD300		H19W05	H70WDK15	WA6229
KAMD42 A/ B/ P-A		H19W05	H70WK02	WA6229
KAMD43 P-A		H19W05	H70WK02	WA6229
KAMD44 A/ B/ C/ P-A/ P-B/ P-C		H19W05	H70WDK15	WA6229
KAMD300		H19W05	H70WDK15	WA6229
MB10A		H11W01	E75KD42 (Forfilter/ Innsats) *** H30WK01 (Spin on) E2KP (Hovedfilter/ Innsats)	
MB18/ F		H10W22	E75KD42 (Innsatsfilter)	
MB20 A/ B/ C		H10W22	E75KD42 (Innsatsfilter)	
MD1		H11W01	E2KP (Innsats)	
MD1B		H11W01	E75KD42 (Forfilter/ Innsats) *** H30WK01 (Hovedfilter/ Skru) E2KP (Hovedfilter/ Innsats)	

* Originalnr.

D12 / D13 kan også ha flate luftfilter 3818541 = 21702999 (som D11).

** Her kan man også bruke H70WK02 med tapping.

*** E75KD42 (87x72mm), kan også være E76K D42 (87x112).

**** Kan ha enten 51596 ELLER H19W05

Rundt luftfilter Ø 206MM = 42473

Rundt luftfilter Ø 155MM = SA6092

Veivhusfilter se side 14!

VOLVO PENTA Forts.

MOTORTYPE	HK.	OLJE	DRIVSTOFF	LUFT
MD2/ B MD3/ B		H11W01	E75KD42 (Forfilter/ Innsats) *** H30WK01 (Spin on) E2KP (Hovedfilter/ Innsats)	
MD4			E5KP D12 (Innsats 70x115)	
MD5/ A/ B/ C		H11W01	E75KD42 (Forfilter/ Innsats) *** H30WK01 (Spin on) E2KP (Hovedfilter/ Innsats)	
MD6/ A/ B		H11W01	H60WK07 (Spin on) **	
MD7/ A/ B	13	H11W01	H60WK07 (Spin on) **	
MD11 A/ B/ C/ D		H11W01	H30WK01 (Spin on) E2KP (Innsats)	
MD17A/ B/ C/ D		H11W01	H30WK01 (Spin on) E2KP (Innsats)	
MD20B		MH3350		
MD21 / A/ B		H10W22 (Gjenger 3/4"-16) H90W03 (Gjenger 18 x 1.5mm)	E75KD42 (Innsatsfilter)	42473 ****
MD22A/ B		WL7212	H60WK07 (Spin on) **	
MD22B		H10W22	H60WK07 (Spin on) **	
MD22L-A		WL7212	H70WK02	
MD22L-B/ P-B		H10W22	H70WK02	
MD30A/ B/ D/ AO		H10W22	E75KD42 (Forfilter/ Innsats) *** H60WK07 (Spin on) **	WA6229
MD31A		H10W22	H60WK07 (Spin on) **	42473
MD32A		H90W03	E75KD42 (Innsatsfilter)	
MD38			E5KP D12 (Innsats 70x115)	
MD40A/ B		51596	E75KD42 (Forfilter/ Innsats) *** H60WK07 (Spin on) **	WA6229
MD42A		H19W05	E75KD42 (Innsatsfilter)	
MD47A/ B			E5KP D12 (Innsats 70x115)	WA6229
MD50A		H19W05	E10KFR4 D10	E220L
MD67A/ B			E5KP D12 (Innsats 70x115)	
MD70 / A/ B/ C		H19W05	E75KD42 (Forfilter/ Innsats) *** E10KFR4D10 (Hovedf./Innsats) H60WK07 (Spin on) **	46670
MD86B			E5KP D12 (Innsats 70x115) E10KFR4 D10 (Innsats 83x145)	
MD96A/ B			E5KP D12 (Innsats 70x115) E10KFR4 D10 (Innsats 83x145)	
MD100A/ B		H19W05	H60WK07 (Spin on) ** E10KFR4D10 (Innsats)	46670
MD120A/ B		H19W05	H60WK07 (Spin on) ** E10KFR4D10 (Innsats)	46670
MD120C		H200W10	H60WK07 (Spin on) ** E10KFR4D10 (Innsats)	46670
MD2010 A/ B (2 Cyl.)	10	H97W01	E75KD42 (Forfilter/ Innsats) *** NF-2252 (Spin on)(Hoved filter)	
MD2010C/D		MH3350	E75KD42 (Forfilter/ Innsats) *** NF-2252 (Spin on)(Hoved filter)	
MD2020 A/ B/ C/ D (3 Cyl.)	18	MH3350	E75KD42 (Forfilter/ Innsats) *** NF-2252 (Spin on)(Hoved filter)	
MD2030 A/ B/ C/ D (3 Cyl.)	28	MH3373	E75KD42 (Forfilter/ Innsats) *** NF-2252 (Spin on)(Hoved filter)	
MD2040 A/ B/ C/ D (3 Cyl.)	38	MH3373	E75KD42 (Forfilter/ Innsats) *** NF-2252 (Spin on)(Hoved filter)	

* Originalnr.

** Her kan man også bruke H70WK02 med tapping.

*** E75KD42 (87x72mm), kan også være E76K D42 (87x112).

**** Kan ha enten 51596 ELLER H19W05

Rundt luftfilter Ø 206MM = 42473

Rundt luftfilter Ø 155MM = SA6092

Veivhusfilter se side 14!

VOLVO PENTA Forts.

MOTORTYPE	HK.	OLJE	DRIVSTOFF	LUFT
TAM61		H200W10	H60WK07 (Spin on) **	WA6229
TAM71		H200W10	H60WK07 (Spin on) **	WA6229
TAMD22A		WL7212	H60WK07 (Spin on) **	
TAMD22B/ C		H10W22	H60WK07 (Spin on) **	
TAMD22P-B		H10W22	H70WK02	
TAMD30A/ B/ D/ AO		H10W22	H60WK07 (Spin on) **	WA6229
TAMD31A/ B/ C/ D/ L- A/ M- A/ P- A		H10W22	H60WK07 (Spin on) **	42473 Eldre/ SA6092 Nyere
TAMD40/ B		51596	E75KD42 (Forfilter/ Innsats) *** H60WK07 (Spin on) **	WA6229
TAMD41A/ B/ D/ H- A/ H- B L- A/ M- A/ P- A		51596 (108 X 132) H19W05 (62 X 181)	E75KD42 (Forfilter/ Innsats) *** H60WK07 (Spin on) **	42473 Eldre / SA6092 Nyere
TAMD42WJ-A		51596 (108 X 132) H19W05 (62 X 181)	H70WK02	WA6229
TAMD60A/ B/ C		H19W05	H60WK07 (Spin on) **	46670
TAMD61A		51798 (Gjenger 1 1/2"-16)**** 51036 (Gjenger 18 x 1.5mm)	H60WK07 (Spin on) **	WA6229
TAMD62A		51798 (Gjenger 1 1/2"-16)**** 51036 (Gjenger 18 x 1.5mm)	H60WK07 (Spin on) **	WA6229
TAMD63 L- A/ P- A		51798 (Gjenger 1 1/2"-16)**** 51036 (Gjenger 18 x 1.5mm)	H60WK07 (Spin on) **	3825038*
TAMD70 B / C		H19W05	E75KD42 (Forfilter/ Innsats) *** H60WK07 (Spin on) **	46670
TAMD70D/ E		51596	H60WK07 (Spin on) **	46670
TAMD71A/ B		51798 (Gjenger 1 1/2"-16)**** 51036 (Gjenger 18 x 1.5mm)	H60WK07 ** (Innv. Gjenger) H34WK (Utv. Gjenger)	WA6229
TAMD72A/ P- A		51798 (Gjenger 1 1/2"-16)**** 51036 (Gjenger 18 x 1.5mm)	H60WK07 ** (Innv. Gjenger) H34WK (Utv. Gjenger)	WA6229
TAMD73EDC		51798 (Gjenger 1 1/2"-16)**** 51036 (Gjenger 18 x 1.5mm)	H60WK07 (Spin on) **	
TAMD73P- A/ W- J- A		51798 (Gjenger 1 1/2"-16)**** 51036 (Gjenger 18 x 1.5mm)	H60WK07 (Spin on) **	3827167* = 3838952*
TAMD74A- A / A- B / C- A / C- B L- A / L- B / P- A / P- B		51798 (Gjenger 1 1/2"-16)**** 51036 (Gjenger 18 x 1.5mm)	H60WK07 (Spin on) **	3827167* = 3838952*
TAMD75P- A		51798 (Gjenger 1 1/2"-16)**** 51036 (Gjenger 18 x 1.5mm)	H60WK07 (Spin on) **	3827167* = 3838952*
TAMD102 A/ D		H200W10 (Full flow) H200WN01 (By pass)	H60WK07 (Spin on) **	46670
TAMD103 A/ C		H200W10 (Full flow) H200WN01 (By pass)	H60WK07 (Spin on) **	46670
TAMD120A		H19W05	H60WK07 (Spin on) ** E10KFR4D10 (Innsats)	46670
TAMD120B/ C		H200W10	H60WK07 (Spin on) ** E10KFR4D10 (Innsats)	46670
TAMD121C/ D		H200W10	H60WK07 (Spin on) ** E10KFR4D10 (Innsats)	46670
TAMD122 / A/ C/ D/ P- A/ P- B		H200W10 (Full flow) H200WN01 (By pass)	H60WK07 ** (Innv. Gjenger) H34WK (Utv. Gjenger)	46670
TAMD162A/ B/ C TAMD163/ A- A/ P- A		H200W10 (Full flow) H200WN01 (By pass)	H60WK07 ** (Innv. Gjenger) H34WK (Utv. Gjenger)	46670
		Vannfilter H28WF		
TAMD165A/ C/ P		H200W40 (Full flow) H200WN0101 (By pass)	H34WK (Utv. Gjenger)	46670
THAMD70B/ C		51596	H60WK07 (Spin on) **	46670
TMD22A		WL7212	H60WK07 (Spin on) **	
TMD22B/ C		H10W22	H60WK07 (Spin on) **	
TMD30A/ B/ D/ AO		H10W22	E75KD42 (Forfilter/ Innsats) *** H60WK07 (Spin on) **	42473
TMD31A/ B/ D/ L- A		H10W22	E75KD42 (Forfilter/ Innsats) *** H60WK07 (Spin on) **	42473

* Originalnr.

** Her kan man også bruke H70WK02 med tapping.

*** E75KD42 (87x72mm), kan også være E76K D42 (87x112).

**** Passer på de fleste modeller.

***** 51798 hovedfilter / 51036 bypassfilter

Rundt luftfilter Ø 206MM = 42473

Rundt luftfilter Ø 155MM = SA6092

Veivhusfilter se side 14!

VOLVO PENTA Forts.

MOTORTYPE	HK.	OLJE	DRIVSTOFF	LUFT
TMD40A/ B/ C		51596	E75KD42 (Forfilter/ Innsats) *** H60WK07 (Spin on) **	42473
TMD41A/ B/ D/ L-A		51596	E75KD42 (Innsats)	42473
TMD47B		51596	E75KD42 (Forfilter/ Innsats) *** H60WK07 (Spin on) **	
TMD50A				E220L ****
TMD70/ A/ B		H19W05	E75KD42 (Forfilter/ Innsats) *** H60WK07 (Spin on) **	E291L ****
TMD70 C		H19W05	E75KD42 (Forfilter/ Innsats) *** H60WK07 (Spin on) **	46670
TMD96A/ B		VP. 417065*	E5KP D12(Innsats 70x115)	
TMD100A/ B		H19W05	H60WK07 (Spin on) ** E10KFR4D10 (Innsats)	46670
TMD100C		H200W10	H60WK07 (Spin on) **	46670
TMD102A		H200W10	H60WK07 (Spin on) **	46670
TMD120A		H19W05	H60WK07 (Spin on) ** E10KFR4D10 (Innsats)	46670
TMD120B/ C		H200W10	H60WK07 (Spin on) * E10KFR4D10 (Innsats)	46670
TMD121C		H200W10	H60WK07 (Spin on) * E10KFR4D10 (Innsats)	46670
TMD122A		H200W10	H60WK07 (Spin on) * E10KFR4D10 (Innsats)	46670
3,0 GL/ GS		57099	33231 (Gjenger 1"-14) 33225 (Gjenger 11/16"-16) 33359 (Gjenger 13/16"-18)	
4,3 GL/ GS/ Gi (V6)		51036	33231 (Gjenger 1"-14) 33225 (Gjenger 11/16"-16) 33359 (Gjenger 13/16"-18)	
4,3 GL-J/JF, GXi-J/JF, OSi-J/JF		E27HD84 Innsats	33359 (GL-J, JF) (3847644) (GXi, OSi)	
5,0 FL/Fi		H17W02	33231 (Gjenger 1"-14) 33225 (Gjenger 11/16"-16) 33359 (Gjenger 13/16"-18)	
5,0 GXi-G/GXi-GF/OSi-G, OSi-GF		51060 (96x130)Spin-on	33359 (Gjenger 13/16"-18)	
5,0 GL-J/JF, GXi-J/JF, OSi-J/JF		E27HD84 Innsats	33359 (GL) (3847644) (GXi, OSi)	
5,7 GL/ Gi		57099	33231 (Gjenger 1"-14) 33359 (Gjenger 13/16"-18)	
5,7 GS/ GSi/ Gxi		51060 (96x130)	33231 (Gjenger 1"-14) 33359 (Gjenger 13/16"-18)	
5,7 Gi300-J/JF, 5,7 Osi-J/JF, 5,7 Gxi-J/JF, 5,7 OSXi-J/JF		E27HD84 Innsats	(3847644) (GXi, OSi)	
5,8 FL/ Fi/ FSi		H17W02	33231 (Gjenger 1"-14) 33225 (Gjenger 11/16"-16) 33359 (Gjenger 13/16"-18)	
7,4 GL/ Gi/ Gsi		57099 (96x107) 51060 (96x130)	33231 (Gjenger 1"-14) 33359 (Gjenger 13/16"-18)	
8,1 Gi/ Gsi/ Gxi		51060 (96x130)	33231 (Gjenger 1"-14) 33359 (Gjenger 13/16"-18)	
8,1Gi-J/JF/GXi-J/JF/OSi-J/JF		E27HD84 Innsats	(3847644) (GXi, OSi)	
8,2 GL/ Gsi		57099 (96x107) 51060 (96x130)	33231 (Gjenger 1"-14) 33359 (Gjenger 13/16"-18)	

* Her kan man også bruke H70WK02 med tapping.

Rundt luftfilter Ø 206MM = 42473

Rundt luftfilter Ø 155MM = SA6092

VW

MOTORTYPE	KW	OLJE	DRIVSTOFF	LUFT
SDI 40-4	29	E19HD83	H119WK	065133843*
SDI 50-4	37	E19HD83	H119WK	065133843*
SDI 55-5	40	E325HD21	H119WK	065133843*
SDI 60-4	44	E19HD83	H119WK	065133843*
SDI 75-5	55	E325HD21	H119WK	065133843*
TDI 75-4	55	E19HD83	H119WK / E0530K01	065133843*
TDI 100-5	74	E325HD21	H119WK	065133843*
TDI 115-4	85	E19HD83	H119WK	
TDI 120-5	88	E325HD21	H119WK	065133843*
TDI 150-5	111	E325HD21	H119WK	065133843*
TDI 165-5	121	E325HD21	H119WK / E0530K01	065133843*
TDI 225-6	165	E73HD134	H119WK / E0530K01	
TDI 265-6	195	E73HD134	H119WK / E0530K01	
TDI 270-6	195	E73HD134	H119WK	
TDI 350-8	257	E73HD134	H119WK / E0530K01	

* Originalnr.

YAMAHA**UTENBORS MOTORER**

MOTORTYPE	HK.	OLJE	DRIVSTOFF	LUFT
F9,9C	9,9	51358	*	
F9,9D	9,9	51358	*	
F15 (1998-2001)	15	51358	*	
F15A	15	51358	*	
F20A	20	51358	*	
F25 (1998-1999)	25	51358	*	
F25A	25	51358	*	
F30A (2001-)	30	51358	*	
F40 (1999-2001)	40	51358	*	
F40A,B	40	51358	*	
F40C (2001-)	40	51358	*	
F45A	45	51358	*	
F50 (1995-1998)	50	51358	*	
F50A	50	51358	*	
F50F (2001-)	50	51358	*	
F60A (2001-)	60	51358	*	
F80 (1999-2001)	80	51358	*	
F80A	80	51358	*	
F80B (2001-)	80	51358	*	
F100 (1999-2001)	100	51358	*	
F100A	100	51358	*	
F100D (2001-)	100	51358	*	
F115A	115	51358	*	
F150A/ F	150	57000	*	
F200A/ F	200	57000	*	
F225A/ F	225	57000	*	
F250A/ F	250	57000	*	
F300	300	57000		
FT25B (2001-)	25	51358	*	
FT40 (1999-2001)	40	51358	*	
FT50B	50	51358	*	
FT50C/ G (2001-)	50	51358	*	
FT60B/ D (2001-)	60	51358	*	

* Slangefilter kan være 33002 (8mm) eller 33003 (10mm).

Noen har drivstoff filter med gjenger for brakett.

YAMAHA**INNENBORDS MOTORER**

MOTORTYPE	HK.	OLJE	DRIVSTOFF	LUFT
3,0L L4 EST		H10W16	*	
4,3L V6 EST		51036	*	
4,3L V6 YEMS		H17W02	*	
5,0L V8 EST		57099 (96x107) 51060 (96x130)m/ventil 57099 (97x111)m/ventil	*	
5,0L V8 YEMS		H17W02	*	
5,7L V8 EST		H10W16	*	
5,7L V8 YEMS		H17W02	*	
7,4L V8 EST		H17W02	*	

* Bensinfilter med vannseparator kan være 33225 (Se side 5.)

YANMAR

MOTORTYPE	HK.	OLJE	DRIVSTOFF	LUFT
SB 8	8	104271-35130*	33262	
SB 12	12	104271-35130*	33262	
SVE 8		104271-35130*		
SVE 12		104271-35130*		
YSB 8	8	104271-35130*	33262	
YSB 12	12	104271-35130*	33262	
YSE 8	8	104271-35130*	33262	
YSE 12	12	104271-35130*	33262	
YSM 8	8	104271-35130*	33262	
YSM 12	12	104271-35130*	33262	
1 GM	7,5	MO-429	33262	128170-12540*
1 GM 10	9	MO-429	33262	128171-12540*
2 GM	15	MO-429	33262	128270-12540*
2 GM 20	18	MO-429	33262	128270-12540*
2 GM 20-F	18	MO-429	33262	128270-12540*
2 GM 20-F-YEU		MO-429	33262	128377-12530*
2 GM 20-YEU		MO-429	33262	128377-12530*
2 GM-F	15	MO-429	33262	128270-12540*
2 QM		MO-523	YO-9006	124770-12540*
2 QM 15	15	MO-429	33262	124770-12540*
2 QM 20	22	MO-523	33262	124770-12540*
2 YM 15	14	FO-011A	33262	124770-12540*
3 GM	22,5	MO-429	33262	128270-12540*
3 GM 30	27	MO-429	33262	128270-12540*
3 GM 30-F	27	MO-429	33262	128270-12540*
3 GM 30-F-YEU		MO-429	33262	128377-12530*
3 GM 30-YEU		MO-429	33262	128377-12530*
3 GM-F	22,5	MO-429	33262	128270-12540*
3 HM	30,5	MO-523	33262	124770-12540*
3 HM 35	34	MO-523	33262	124770-12540*
3 HM 35-F	34	MO-523	33262	124770-12540*
3 HM-F	30,5	MO-523	33262	124770-12540*
3 JH 2-E	36	FO-011A	DF-7751	
3 JH 2-TE	60	FO-011A	DF-7751	129470-12330*
3 JH-3E	38	FO-011A	DF-7751	
3 JH 3E-YEU		FO-011A	DF-7751	
3 JH-4BE	38	FO-011A	DF-7751	
3 JH-4E	38	FO-011A	DF-7751	
3 JH-5E	38	FO-011A	DF-7751	
3 QM		MO-523	YO-9006	124970-12540*
3 QM 30	33	MO-523	33262	124770-12540*
3 YM 20	20	FO-011A	33262	128270-12540*
3 YM 30	29	FO-011A	33262	128270-12540*
4 BY-Serie (BMW)		E32HD26	SK3237 / 120650-55040* 120650-55021*	120650-12510*
4 JH 2-DTBE	60	MO-432	DF-7751	

* Originalnr.

YANMAR Forts.

MOTORTYPE	HK.	OLJE	DRIVSTOFF	LUFT
4 DET 2-DTE	88,4	MO-432	DF-7751	
4 JH 2-E	48	MO-432	DF-7751	129470-12330*
4 JH 2-HTE	72	MO-432	DF-7751	129470-12330*
4 JH 2M-E	47	MO-432	DF-7751	
4 JH 2-TE	85	MO-432	DF-7751	129470-12330*
4 JH 2-DTE	88,4	MO-432	DF-7751	129470-12330*
4 JH 2-UTE	96	MO-432	IF-353	129470-12330*
4 JH 3-DTE (År 2000)	120	MO-429	IF-353	129470-12330*
4 JH 3-DTHE	120	57356	IF-353	
4 JH 3-E	53	MO-429	DF-7751	
4 JH 3 E-YEU		MO-432	DF-7751	
4 JH 3-HTE	100	MO-429	IF-353	129470-12330*
4 JH 3-T	72	MO-429	IF-353	
4 JH 3-TE	75	MO-429	IF-353	129470-12330*
4 JH 3-UTE		MO-429	IF-353	
4 JH 4-E		MO-429	DF-7751 / IF-353 m/føler.	
4 JH 4-T		57356	IF-353	
4 JH 4-TE	72	MO-429	IF-353	129470-12330*
4 JH 4-HTBE	107	57356	IF-353	
4 JH 4-HTE	110	MO-429 /57356	IF-353	129470-12330*
4JH -HTHE				
4 JH 4-HTHXE	107	57356	IF-353	
4 JH 4-T		57356	IF-353	
4 JH 4-TBE	72	57356	IF-353	
4 JH 4-TE	72	57356	IF-353	
4JH 4-TEXE	107	57356	IF-353	
4 JH 5-BE	52	57356	IF-353	
4 JH 5-E	52	57356	DF-7751	
4 JH 45	45		WF10176	
4 JH 57	57		WF10176	
4 JH 80-SPP			WF10176	
4 JH-DTBE	88	MO-432	DF-7751	
4 JH-DTE	77	MO-432	DF-7751	
4 JH-DTXE	74	MO-432	DF-7751	
4 JH-E	44	MO-432	DF-7751	129470-12330*
4 JH-HTE	66	MO-432	DF-7751	
4 JH-HTXE	63	MO-432	DF-7751	
4 JH-TE	55	MO-432	DF-7751	129470-12330*
4 JH-XE	41	MO-432	DF-7751	
4 JM	40	MO-523	DF-7751	
4 JM-T	50	MO-523	DF-7751	
4 JM-TE	50	MO-523	DF-7751	
4 LH-DTE	165	NO-228	YF-9107	119195-18880*
4 LH-HTE	135	MH390	MF-557	119195-18880*
4 LH-STE	220	NO-228	YF-9107	119195-18880*
4 LH-STZ	222	NO-228	YF-9107	
4 LH-TE	105	MH390	MF-557	119195-18880*
4 LHA-DTE/ DTZE	184/	NO-228	YF-9107	119195-18880*
4 LHA-DTP	200	NO-228	YF-9107	119195-18880*
4 LHA-DTP	184	NO-228	YF-9107	
4 LHA-HTE/ HTZE	150/	NO-228	MF-557	119195-18880*
4 LHA-HTP	144	NO-228	YF-9107	
4 LHA-HTP	160	NO-228	MF-557	
4 LHA-STE/ STZE		NO-228	YF-9107	119195-18880*
4 LHA-STP	222	NO-228	YF-9107	
4 LHA-STP	240	NO-228	YF-9107	
4 LHA-STZ		NO-228	YF-9107	
4 LHM-STE	222	NO-228	YF-9107	
6 BY-Serie		E28H01D26	SK3237	120660-12510*
6BY2-SERIE		E28H01D26	WF10213	120660-12510*
6 CX530	514			
6 LP-DTA		TO-140	TF-1652	
6 LP-DTE - DTZE	240	TO-140	TF-1652	119195-18880*
6LP-DTP / DTZP		TO-140	X5186100664*	119195-18880*
6 LP-STE - STZE	290	TO-140	TF-1652	119195-18880*

6 LP-STZE	270	TO-140	TF-1652	119195-18880*
-----------	-----	--------	---------	---------------

* Originalnr.

YANMAR Forts.

MOTORTYPE	HK.	OLJE	DRIVSTOFF	LUFT
6 LP-STP - STZP	270	TO-140	TF-1652	119195-18880*
6 LPA-DET		TO-140	TF-1652	119195-18880*
6 LPA-DTP	260	TO-140	TF-1652	119195-18880*
6LPA -STEP 2	292	TO-140	TF-1652	119195-18880*
6 LPA-STP	295	TO-140	TF-1652	119195-18880*
6 LPA-STP	314	TO-140	TF-1652	119195-18880*
6 LPA-STP2	295	TO-140	TF-1652	
6 LPA-STXP2	290	TO-140	TF-1652	
6 LPA-STZP	270	TO-140	TF-1652	
6 LPM-DTE	240	TO-140	TF-1652	
6 LPM-STE	290	TO-140	TF-1652	
6 LY-STE	340	51825 /	WF10452	119593-18880 /-01*
6 LY-UTE	305	51825 / SO6198**	WF10452	119593-18880 /-01*
6 LYA-STE	350	51825 /	WF10452	119593-18880 /-01*
6 LYA-UTE	315	51825 /	WF10452	119593-18880 /-01*
6 LY2-STE	408	51825 / SO6198**	WF10452	119593-18880 /-01*
6 LY2A-STP		51825 / SO6198**	WF10452	119593-18880 /-01*
6 LY3-ETP	480	51825 / SO6198**	WF10452	
6 LY3-STC	440	51825 / SO6198**	WF10452	
6 LY3-STP	440	51825 / SO6198**	WF10452	
6 LY3-UTC	380	51825 / SO6198**	WF10452	
6 LY3-UTP	380	51825 / SO6198**	WF10452	
6LYM-STE		51825	WF10452	119593-18880 /-01*
6LYM-UTE		51825	WF10452	119593-18880 /-01*
6 SY-STP	700			
8LV320	320	WL7411	TF-1652	119195-18880*
8LV370	370	WL7411	TF-1652	119195-18880*
8 SY-STP	873			

* Originalnr.

** SO6198 er bypass.

Noen har også CAV296 forfilter = E75KD42.

FILTER TIL RACOR FILTERHUS

FILTERHUS	FILTER DRIVSTOFF		
	2MY	10MY	30MY
73/ 1000	33793	33792	33791
75/ 500	33796	33795	33794
75/ 900	33799	33798	33797
75/ 1000	33793	33792	33791
77/ 1000	33793	33792	33791
79/ 1000	33793	33792	33791
110	33438	33431	
120	33582	33583	33584
140	33582	33583	33584
215	33433	33435	
220	33426	33445	33447
225	33446	33443	33211
230	33776	WF8245	33614
245	33775	33771	
390	33788		H7090WK30
445	33773	S3204T*	33755
460	R60S*	33231	
490	33788	WF10022	H7090WK30
500	33796	33795	33794
690	33788		H7090WK30
900	33799	33798	33797
1000	33793	33792	33791
800-12	33793	33792	33791
800-20	33793	33792	33791
800-30	33793	33792	33791
4120	H7120WK10	WF10022	33774

*Originalnr.

FILTER TIL SEPAR FILTERHUS

FILTERHUS	FILTER DRIVSTOFF		
	2MY	10MY	30MY
KWA20			71-20530*
KWA50	33796	33795	33794
KWA90	33799	33798	33797
KWA100	33793	33792	33791
SWK2000		E1010K	E1030K
SWK2000/5		E0530K	
SWK2000/18		SEPAR 01810*	SK3946-HNBR

*Originalnr.

FILTER TIL VEIVHUS

FILTERHUS	FILTER
CV6000	WS10108
CCV4500	WS10107

FILTER TIL GEAR

TYPE BETEGNELSE	FILTER
HURT HSW 630 A1	HY90491
HURT HSW 710	H10WD01
HURT HSW 710A	H10WD01
HURT HSW 800A	H10WD01
HURT HSW 800V	H10WD01
HURT HVP 15	3013-S40
HURT HVP 25	3013-S40
HURT HVP 50	H17W01
HURT 450	HY90491
PRM (Ikke på PRM 140)	471 / UTGÅTT
ZF45A	HY90491
ZF45H	HY90491
ZF63	HY90491
ZF80	HY90491
ZF85	HY90491
ZF285	51545
ZF305	51545
ZF305A	57819
ZF312	51545
ZF325A	H17W02
ZF325IVTS	57819
ZF350	51545
ZF2070V	0501212459*
ZF W320	51545

Overgangsliste Racor nr. til M-T nr.

Racor nr.	M-T nr.
R12P	33584
R12S	33582
R12T	33583
R20P	33614
R20S	33776
R20T	WF8245
R24S	33426
R25P	H7025WK30
R25S	33775
R25T	33771
R26P	33211
R26T	H703WK / 33446
R45P	33755
R45S	33773
R52T	WF8201
R60P	33231
R60T	33231
R90P	H7090WK30
R90S	33788
R120P	33774
R260P	H700WK

Racor nr.	M-T nr.
S3201S	33783
S3208P	33724
S3211TUL	SK3237
S3213T	33769
S3214T	33770
S3220UL	33769
S3227	33757
S3232	33746
S3240	33583
S3201P	WF10212
S3201T	WF10022
S3204	33239
2010 PM-30	33794
2010 SM-2	33796
2010 TM-10	33795
2020 PM-30	33791
2020 SM-2	33793
2020 TM-10	33792
2040 PM-30	33797
2040 SM-2	33799
2040 TM-10	33798

Overgangsliste Separ nr. til M-T nr.

00510	E0510K	B: 76 x B: 76 x H: 24
00530	E0530K	B: 76 x B: 76 x H: 24 Org. Separ
0530/50H	E0530K02	B: 89 x B: 89 x H: 55,5 Org. Separ
01010	E1010K	B: 89 x B: 89 x H: 55 Org. Separ
01030	E1030K	B: 76 x B: 76 x H: 54 Org. Separ
01030HV	E1030K01	B: 89 x B: 89 x H: 54 Org. Separ
01830	SK3946-HNB	B: 76 x B: 76 x H: 24

VI KAN OGSÅ LEVERE:

ARCO, DELCO REMY, DIXIE, ELSTOCK, LUCAS/CAV

MITSUBISHI, PRESTOLITE/LEECE-NEVILLE, VALEO

- Startere, Alternatorer og Boggjeløftmotorer til de fleste kjøretøy og maskiner.
- Startere, Alternatorer og Dynastartere til marine motorer.
- Startere og Alternatorer til utenbordsmotorer.
- Tilt-/ Trim motorer til hekkagregater og utenbordsmotorer
- EGR Ventiler.
- AC- Kompressorer.
- Kupevifter.
- Stort utvalg av deler til startere og alternatorer.
- Bremsedalipere
- Servopumper

FIAMM

- Horn for bil, lastebil og marine.

BLUESEA, MTA, NAGARES, WERHLE

- Sikringsholdere, Sikringer, Kabelsko, Brytere, Releèr, Tilhengerstøpsel/ kontakter m.m.

AMOKABEL

- Kabel / Fortinned

AMC, HENGST, WIX

- Filter for Europeisk. Japanske og Amerikanske biler, busser, lastebiler og marine/ Filterholdere.

BULLBOY / BULLPRO / LEDWISE / OCEAN VISION / X-VISION / SAE

- Arbeidslamper, varsellys og ekstralys, markeringslys, frontlys, baklys, lommelykter, hodelykter.

COHLINE

- Diesel rekvesita, Slanger, Nipler og Bremsørør.

BCD, FCM, HARDI, SOFABEX

- Mekaniske fødepumper for diesel og elektriske fødepumper for bensen og diesel.

SPACO

- Pakningssett for dieselpumper og dieselrekvisita.

BOSCH, NGK, CHAMPION

- Glødeplugg og Tennplugg til bil og marine.

BOSCH

- Viftereimer, Kilereimer, Multireimer.

CAV, SYNCHRO-START, WOODWARD

- Stoppsolenoider.

NWB, VALEO

- Vinduspusser blader. Produsert av original leverandør.

BENTON, TRANSPO, MOBILETRON, NOCO

- Regulatorer, Likerettere, Tenningsmoduler, Skilledioder og Omformere 24V-12V.
Converter (12-230V og 24-230V), Batterilader, Startbooster

Vi sjekker gjerne det "umulige"!

Marinedeler24

Torvveien 2

1940 Bjørkelangen

INFO@MARINEDELER24.NO

Tlf: 930 16 213

M
A
R
I
N
E
L
I
S
T
S
E

N
R
2
1