

# Rekvisitakatalog

Personbil | Varebil | Lastebil/Buss | Landbruk | Bygg/Anlegg | Marine



Batteriladere

Boggiløft motorer

Brytere

Filter / Filterholdere

Fødepumper

Hansker / Støvmasker

Horn

Hovedstrømbrytere

Innvertere

Kabel

Kabelsko

Koblingsmateriell

Lanterner

Lykter

Lyspærer

Monteringsutstyr for lys

Omformere

Pumper

Releer

Ryggekameraer

Sikringer

Skilledioder

Slanger

Stoppmagneter

Strips

Støpsler og kontakter

Tenningslåser

Tennplugger

Verktøy

Viftereimer

Vinduspusser arm /-blad

Vinduspusser-motorspyling

Vinsjer

# I N N H O L D S F O R T E N G N E L S E





ADAPTER FOR TILHENGERKABEL	54
ARBEIDSHANSKER	1
ARBEIDSLAMPER LED	80
ARBEIDSLYS	62
BAKLYS	62
BATTERI POLSKO	19
BATTERIER FOR LOMMELYKTER MM.	81
BATTERILADERE	42-43, 81
BENSINPUMPER	87
BLINDPLUGG	104, 106
BLINK RELEER	35
BOGGILØFTMOTORER /-BRYTERE	110-112
BRYTERE	29-30
BRYTERPANEL	31
BUNKRINGSPUMPER	87
DIESELPUMPER	87, 150-160
DIESELREKVISITA	103
DRIVSTOFFPUMPER	87
DT-KONTAKTER	68-71
EKSTRALYS	62
EURO KONTAKTER	45
FESTEKLAMMER	24
FESTEMATERIELL	23
FILTER TENGER	99
FILTRE OG FILTERHOLDERE	92-98
FITTINGS FOR RØR OG SLANGER	103
FØDEPUMPER VOGNLISTE & BILDER	150-160
GLØDERELE	35
GRÅVANNS PUMPER	90
GUMMIHETTER FOR POLSKO	19
HORN	108
HOVEDLYS	62
HOVEDSTRØMBRYTERE	25-27
HOVEDSTRØMSRELEER	36-38
HULLSKRUER	103
HÅNDPUMPE FOR PÅHENGSMOTOR	87
HÅNDPUMPER FOR DIESEL	91
HÅNDRENS	2
INNSLAGSRELEER	36-38
INVERTERE	48-49

<b>I N N H O L D S F O R T E G N E L S E</b>	ISOLASJONS STRØMPER	21
	KABEL	3-5
	KABELSAKS	20
	KABELSKO /-SETT	15-18
	KABELSKOTENGER	20
	KABELSTRØMPER	21
	KAROSSERIKLIPS	114
	KOBBERINGER	107
	KOBLINGSBOKSER	14
	KOBLINGSPUNKTER /-SKINNER	13
	KONTAKTER / STRØM UTTAK	50-55
	KONTAKTER FOR ALTERNATORER	39
	KONTROLL LAMPER	31
	KRYMPESTRØMPER	21
	LADEKABLER FOR TELEFON MM.	113
	LADEKONTAKTER	44-45
	LANTERNER	76-78
	LENSEPUMPER MANUELL / ELEKTRISK	88-90
	LODDETINN	17
	LOMMELYKTER / HODELYKTER	79-80
	LYS / LYSUTSTYR	62-75
	LYS RELEER	32
	LYSPÆRER	82-86
	LYSTERKLEMMER / SUKKERBITER	16
	MARKERINGSLYS	62
	MINI RELEER	32
	MULTIMETER	116
	MUTTERTREKKER	115
	NATO KONTAKTER	54
	NIPPLER	103-106
	OMFORMERE	47
	OVERSTRØMS VENTIL	104
	PLASTHETTER	105
	PLASTRØR FOR KABEL	24
PLUGG FOR DYSEHOLER	105	
POLSKO /-HETTER	19	
PRØVELAMPE	116	
PUMPER	87, 109	
PÆRESOKLER	67	
RELEER	32-38	
RETURVENTILER	99	

<b>I N N H O L D S F O R T E G N E L S E</b>	<b>RYGGEKAMERAER</b>	<b>58-61</b>
	<b>SIKRINGER</b>	<b>6-9</b>
	<b>SIKRINGSHOLDERE</b>	<b>10-12</b>
	<b>SIRKULASJONSPUMPER</b>	<b>88</b>
	<b>SKILLE RELEER</b>	<b>34, 46</b>
	<b>SKILLEDIODER</b>	<b>46</b>
	<b>SKILTBRACKETTER FOR EKSTRALYS</b>	<b>72-73</b>
	<b>SKJØTEKABLER TIL TILHENGERE</b>	<b>55</b>
	<b>SKRUTREKKER FOR SLANGEKLEMMER</b>	<b>102</b>
	<b>SLANGE BANJOER</b>	<b>103</b>
	<b>SLANGE NIPPLER</b>	<b>103-106</b>
	<b>SLANGEHYLSER</b>	<b>105</b>
	<b>SLANGER / SLANGEKLEMMER</b>	<b>100-102</b>
	<b>START / HOVEDSTRØMS RELEER</b>	<b>36-38</b>
	<b>START BOOSTERE</b>	<b>40-41</b>
	<b>START KNAPPER</b>	<b>29</b>
	<b>STARTKABEL KLYPER</b>	<b>19</b>
	<b>STARTKABELSKO /-SKJØTEHYLSER</b>	<b>18</b>
	<b>STOPPMAGNETER VOGNLISTE OG BILDER</b>	<b>121-149</b>
	<b>STRIPS</b>	<b>23</b>
	<b>STØPSEL</b>	<b>50-55</b>
	<b>STØTTESTAG FOR EKSTRALYS</b>	<b>75</b>
	<b>STØVMASKER</b>	<b>2</b>
	<b>TAPE / TEIP</b>	<b>22</b>
	<b>TENNINGSLÅSER</b>	<b>28</b>
	<b>TENNPLUGGER /- HETTER</b>	<b>117</b>
	<b>TILHENGERSTØPSLER</b>	<b>51-55</b>
	<b>TILT / TRIM RELEER</b>	<b>38</b>
	<b>VANNKRAN MANUELL / ELEKTRISK</b>	<b>88</b>
	<b>VANNUTSKILLER</b>	<b>97</b>
	<b>VARSELLYS</b>	<b>62</b>
	<b>VERKTØY</b>	<b>115-116</b>
	<b>VERKTØY FOR CALIPER STEMPEL</b>	<b>115</b>
	<b>VERKTØY FOR DT-KONTAKTER</b>	<b>71</b>
<b>VERKTØY FOR KABLER</b>	<b>20</b>	
<b>VERNEBRILLER</b>	<b>1</b>	
<b>VIFTEREIMER</b>	<b>118-120</b>	
<b>VINDUS SPYLING</b>	<b>109</b>	
<b>VINDUSPUSSETER MOTORER /- BLADER</b>	<b>110</b>	
<b>VINKELLEDD</b>	<b>106</b>	
<b>VINSJER MANUELL / ELEKTRISK</b>	<b>56-57</b>	



## ARBEIDSHANSKER - VERNEBRILLER

ARBEIDSHANSKER			
Best.nr	Størrelse	Antall	
1720-17609 1720-17600	9 10 Engangshanske Type: 1A Classic	100 100	
3-92041 3-92042 3-92043	9 10 11 Hanske med polyuretanbelagt håndflate og fingre. Beskyttelsesklasse: EN388.	12 12 12	
1-92262 1-92263 1-92264 1-92265	8 9 10 11 Sort og oransje hanske med nitrilbelgt håndflate og fingre. Beskyttelsesklasse: 388.	12 12 12 12	
1-92266 1-92267 1-92268	9 10 11 Sort og oransje hanske med latexbelagt håndflate og fingre. Med mykt og varmt for. Beskyttelsesklasse: EN388.	12 12 12	
VERNEBRILLER			
Best.nr	Beskrivelse		
3-92054	Vernebrille, økonomi.		
1720-28930	Vernebrille, proff. God optisk kvalitet og god beskyttelse også fra siden. Justerbar lengde og vinkel. Herdet antidugg glass. Leveres i microfiberpose som også kan brukes til rengjøring av glassene		

For å se alle modeller eller andre strl., se hele vårt sortiment på [www.importex24.no](http://www.importex24.no)

## STØVMASKER - HÅNDRENS

STØVMASKER		
Best.nr	Beskrivelse	
3-92052	<p>Beregnet for å beskytte mot partikkel forurensning og fint støv som f.eks. ved sliping av ulike matrieler.</p> <p>Beskyttelsesgrad: FFP2V</p> <p>Leveres i 10pk.</p>	
3-92053	<p>Beregnet for å beskytte mot svært fint støv, røyk, damp og bakterier.</p> <p>Beskyttelsesgrad: FFP3V</p> <p>Leveres i 5pk.</p>	
HÅNDRENS		
Best.nr	Beskrivelse	
<b>Håndrens-3L</b> <b>Håndrens-3LB</b> <b>Håndrens-3LP</b>	<p>Håndrens 3 liter.</p> <p>Veggfeste til 3 liter.</p> <p>Pumpe til 3 liter.</p>	
<b>Håndrens-10L</b> <b>Håndrens-10LP</b>	<p>Håndrens 10liter.</p> <p>Pumpe til 10 liter.</p>	

For å se alle modeller eller andre strl., se hele vårt sortiment på [www.importex24.no](http://www.importex24.no)

## KABEL

Kabel dimensjon	Farge	Varebetegnelse	Varenr.	M.pr. rull
1x0,75 Kv	Blå	Kabel	02311272	100
1x0,75 Kv	Brun	Kabel	02311223	100
1x0,75 Kv	Grønn	Kabel	02311258	100
1x0,75 Kv	Grå	Kabel	02311215	100
1x0,75 Kv	Gul	Kabel	02311249	100
1x0,75 Kv	Hvit	Kabel	02311207	100
1x0,75 Kv	Rød	Kabel	02311264	100
1x0,75 Kv	Sort	Kabel	02311231	100
1x1,50 Kv	Blå	Kabel	02311678	100
1x1,50 Kv	Brun	Kabel	02311629	100
1x1,50 Kv	Grønn	Kabel	02311652	100
1x1,50 Kv	Grønn/ Sort	Kabel	02311702	100
1x1,50 Kv	Grå	Kabel	02311611	100
1x1,50 Kv	Gul	Kabel	02311645	100
1x1,50 Kv	Gul/ Grønn	Kabel	0231164552-100M	100
1x1,50 Kv	Gul/ Sort	Kabel	02311703	100
1x1,50 Kv	Hvit	Kabel	02311603	100
1x1,50 Kv	Orange	Kabel	02311683	100
1x1,50 Kv	Rosa	Kabel	02311682	100
1x1,50 Kv	Rød	Kabel	02311660	100
1x1,50 Kv	Rød/ Sort	Kabel	02311700	100
1x1,50 Kv	Sort	Kabel	02311637	100
1x1,50 Kv	Lilla	Kabel	02311694	100
1x1,50 Kv	Sort	Kabel	05173-SORT	100
1x2,50 Kv	Blå	Kabel	02311876	100
1x2,50 Kv	Brun	Kabel	02311827	100
1x2,50 Kv	Grønn	Kabel	02311850	100
1x2,50 Kv	Grå	Kabel	02311819	100
1x2,50 Kv	Gul	Kabel	02311843	100
1x2,50 Kv	Hvit	Kabel	02311801	100
1x2,50 Kv	Rød	Kabel	02311868	100
1x2,50 Kv	Sort	Kabel	02311835	100
1x2,50 Kv	Violett	Kabel	02311892	100
1x4,00 Kv	Rød	Kabel	02312064-NK	50
1x4,00 Kv	Sort	Kabel	02312031-NK	50
1x6,00 Kv	Blå	Kabel	02312277	50
1x6,00 Kv	Rød	Kabel	02312262-NK	50
1x6,00 Kv	Sort	Kabel	02312239-NK	50
1x10,00 Kv	Rød	Kabel	02312460	50
1x10,00 Kv	Sort	Kabel	02312437	50



For å se alle modeller eller andre strl., se hele vårt sortiment på [www.importex24.no](http://www.importex24.no)

## KABEL

Kabel dimensjon	Farge	Varebetegnelse	Varenr.	M.pr. rull
10 Kv	Sort	Myk kabel m/ PVC isolasjon.	VUK10	100
10 Kv	Rød	Myk kabel m/ PVC isolasjon.	VUK10PUN	100
16 Kv	Sort	Myk kabel m/ PVC isolasjon.	VUK16-50M	50
16 Kv	Rød	Myk kabel m/ PVC isolasjon.	VUK16PUN-50M	50
25 Kv	Sort	Myk kabel m/ PVC isolasjon.	VUK25-50M	50
25 Kv	Rød	Myk kabel m/ PVC isolasjon.	VUK25PUN-50M	50
35 Kv	Sort	Myk kabel m/ PVC isolasjon.	VUK35-50M	50
35 Kv	Rød	Myk kabel m/ PVC isolasjon.	VUK35PUN-50M	50
50 Kv	Sort	Myk kabel m/ PVC isolasjon.	VUK50-50M	50
50 Kv	Rød	Myk kabel m/ PVC isolasjon.	VUK50PUN-50M	50
70 Kv	Sort	Myk kabel m/ PVC isolasjon.	VUK70	50
70 Kv	Rød	Myk kabel m/ PVC isolasjon.	VUK70PUN	50
95 Kv	Sort	Myk kabel m/ PVC isolasjon.	VUK95	50
95 Kv	Rød	Myk kabel m/ PVC isolasjon.	VUK95PUN	50
2x0,75 Kv	Rød/ Sort	Høytalerkabel	02321214	100
2x0,75 Kv	Sort	Dobbelt isolert	02314037	100
2x1,50 Kv	Hvit	Dobbelt isolert	02314239	50
2x1,50 Kv	Sort	Dobbelt isolert (Sort/Rød)	02314235	50
2x2,50 Kv	Hvit	Dobbeltisolert	02314700	50
2x2,50 Kv	Sort	Dobbelt isolert (Sort/Rød)	02314730	50
2x4,0 Kv	Sort	Dobbeltisolert	05201-SORT	50
2x4,0 Kv	Grå	Dobbeltisolert	05201-GRÅ	50
2x6,00 Kv	Sort	Dobbeltisolert	05202-SORT	50
3x1,50 Kv	Sort	Kabel	02314334	100
4x0,75 Kv	Sort	Kabel	02314045	100
4x1,50 Kv	Sort	Kabel	02314433	100
5x0,75 Kv	Sort	Kabel	02314052	100
5x1,50 Kv	Sort	Kabel	02314532	100
7x1,50 Kv	Sort	Kabel	02314955	50
7x1,50 Kv	Sort	Kabel	02314955-100M	100
8x1,50 + 5x2,50 Kv	Sort	Kabel	02314999	50
15x1,50 Kv	Sort	Kabel	02315010	50
2x10,00 Kv	Transparent	Dobbeltisolert tvilling kabel	05210-TRANSP	100
2x25,00 Kv	Transparent	Dobbeltisolert tvilling kabel	05225-TRANSP	25
2x35,00 Kv	Transparent	Dobbeltisolert tvilling kabel	05235-TRANSP	25
2x50,00 Kv	Transparent	Dobbeltisolert tvilling kabel	05250-TRANSP	25
7 mm	Sort	Tennpluggkabel m/ kobberleder	02131035	50

## KABEL ADR

Kabel dimensjon	Farge	Varebetegnelse	Varenr.	M.pr. rull
2x1,00Kv	Sort	Kabel ADR	02315002	50
5x1,50 + 2x4,00Kv	Sort	Kabel ADR / EBS	02315007	50
12x1,5 + 3x2,5Kv	Sort	Kabel ADR	02315015	50

For å se alle modeller eller andre strl., se hele vårt sortiment på [www.importex24.no](http://www.importex24.no)

## KABEL

### KABEL MED FORTINNEDE KOBBERLEDERE

Ekstra fleksibel kabel designet for bruk i tøffe arbeidsmiljø.  
Motstandsdyktig mot bensin, smøreoljer og fortynnete syrer.  
Fortinnende kobberledere - PVC isolert.

KV. Dim.	Farge	Varebetegnelse	Diameter	Varenr.	M.pr. rull
1x1,5 KV.	Rød	KABEL FORTINNET	2,4mm	05052T-RØD	100
1x1,5 KV.	Sort	KABEL FORTINNET	2,4mm	05052T-SORT	100
1x2,5 KV.	Rød	KABEL FORTINNET	3mm	05053T-RØD	100
1x2,5 KV.	Sort	KABEL FORTINNET	3mm	05053T-SORT	100
1x4 KV.	Rød	KABEL FORTINNET	3,7mm	05054T-RØD	50
1x4 KV.	Sort	KABEL FORTINNET	3,7mm	05054T-SORT	50
1x6 KV.	Rød	KABEL FORTINNET	4,3mm	05055T-RØD	50
1x6 KV.	Sort	KABEL FORTINNET	4,3mm	05055T-SORT	50
1x10 KV.	Rød	KABEL FORTINNET	6mm	05056T-RØD	50
1x10 KV.	Sort	KABEL FORTINNET	6mm	05056T-SORT	50
2x1,5 KV.	Sort	DOB.ISO. FORTINNET	5,7mm	05175T-SORT	50
2x2,5 KV.	Sort	DOB.ISO. FORTINNET	6,7mm	05200T-SORT	50
2X4 KV.	Sort	DOB.ISO. FORTINNET		05201T-SORT	50
2x6KV.	Sort	DOB.ISO. FORTINNET		05202T-SORT	50
16 KV.	Rød	KABEL FORTINNET	8,3mm	CM16-RØD	50
16 KV.	Sort	KABEL FORTINNET	8,3mm	CM16-SORT	50
25 KV.	Rød	KABEL FORTINNET	10,1mm	CM25-RØD	25
25 KV.	Sort	KABEL FORTINNET	10,1mm	CM25-SORT	25
35 KV.	Rød	KABEL FORTINNET	11,8mm	CM35-RØD	25
35 KV.	Sort	KABEL FORTINNET	11,8mm	CM35-SORT	25
50 KV.	Rød	KABEL FORTINNET	13,3mm	CM50-RØD	25
50 KV.	Sort	KABEL FORTINNET	13,3mm	CM50-SORT	25
70 KV.	Rød	KABEL FORTINNET	15,5mm	CM70-RØD	25
70 KV.	Sort	KABEL FORTINNET	15,5mm	CM70-SORT	25
95 KV.	Sort	KABEL FORTINNET	17,9mm	CM95-SORT	25



For å se alle modeller eller andre strl., se hele vårt sortiment på [www.importex24.no](http://www.importex24.no)



## SIKRINGER

PORSELEN 9x25 Pakn. à 5 stk		
Best.nr.	Amp.	Farge
1569-13050	5 A	Gul
1569-13080	8 A	Hvit
1569-13160	16 A	Rød
1569-13250	25 A	Blå
GLASS 5x20 Pakn. à 5 stk		
1569-06010	1 A	
1569-06020	2 A	
1569-06030	3 A	
1569-06050	5 A	
1569-06100	10 A	
1569-06150	15 A	
1569-06200	20 A	
GLASS 6,3x32 Pakn. à 5 stk		
1569-14010	1 A	
1569-14020	2 A	
1569-14030	3 A	
1569-14050	5 A	
1569-14100	10 A	
1569-14150	15 A	
1569-14200	20A	
1569-14250	25 A	
1569-14300	30 A	
1569-14350	35A	
FLATSTIKK SIKRINGER Pakn. à 5 stk		
1569-03050	5 A	Beige
1569-03075	7,5 A	Brun
1569-03100	10 A	Rød
1569-03150	15 A	Blå
1569-03200	20 A	Gul
1569-03250	25 A	Hvit
1569-03300	30 A	Grønn
FLATSTIKK SIKRINGER Pakn. à 5 stk		
1569-10040	4 A	Rosa
1569-10050	5 A	Beige
1569-10075	7,5 A	Brun
1569-10100	10 A	Rød
1569-10150	15 A	Blå
1569-10200	20 A	Gul
1569-10250	25 A	Hvit
1569-10300	30 A	Grønn
SIKRINGER ASSORTEMENT MINI FLATSTIKK		
06500100 Mini	100stk. 3A-35A m/ klype for flatstikksikringer.	



### Micro

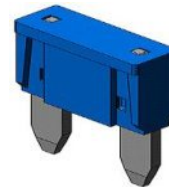

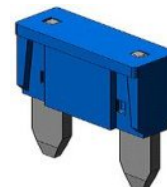

### Mini





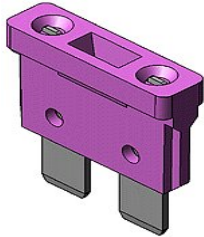

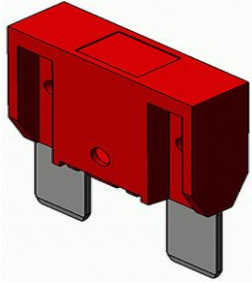
For å se alle modeller eller andre strl., se hele vårt sortiment på [www.importex24.no](http://www.importex24.no)

# SIKRINGER

FLATSTIKK SIKRINGER			Pakn. à 50 stk	<p><b>Norm</b></p> 
Best.nr.	Amp.	Farge		
1600400	3A	Lilla		
1600401	4 A	Rosa		
1600410	5 A	Beige		
1600420	7,5 A	Brun		
1600430	10 A	Rød		
1600440	15 A	Blå		
1600450	20 A	Gul		
1600460	25 A	Hvit		
1600470	30 A	Grønn		
1600375	40 A	Orange		
SIKRINGER ASSORTEMENT FLATSTIKK				
06500120 Normal	120stk. 3A-40A m/ klype for flatstikksikringer.			
FLATSTIKK AUTOMATSIKRINGER			Pakn. à 1 stk	
1557-145008	8 A	Gul		
1557-145010	10 A	Grønn		
1557-145015	15 A	Orange		
1557-145020	20 A	Rød		
1557-145025	25 A	Blå		
1557-145030	30 A	Brun		
FLATSTIKK HOVEDSIKRINGER			Pakn. à 1 stk	<p><b>Maxi</b></p> 
1569-12200	20 A	Gul		
1569-12300	30 A	Grønn		
1569-12400	40 A	Orange		
1569-12500	50 A	Rød		
1569-12600	60 A	Blå		
1569-12700	70 A	Brun		
1569-12800	80 A	Lysegul		
1569-12999	100 A	Lilla		

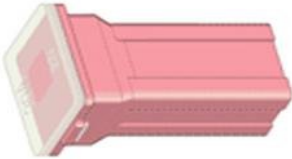
For å se alle modeller eller andre strl., se hele vårt sortiment på [www.importex24.no](http://www.importex24.no)

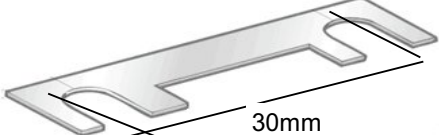
## SIKRINGER

<b>"JAPANSKE" SIKRINGER</b>		<b>Pakn. à 1 stk</b>	
<b>BEST.NR</b>	<b>AMP</b>		
1569-17020	20 A	Lys blå	
1569-17030	30 A	Rosa	
1569-17040	40 A	Grønn	
1569-17050	50 A	Rød	
1569-17060	60 A	Gul	
1569-15020	20 A	Lys blå	
1569-15030	30 A	Rosa	
1569-15040	40 A	Grønn	
1569-15050	50 A	Rød	
1569-15060	60 A	Gul	
1569-16020	20 A	Hvit	
1569-16030	30 A	Rosa	
1569-16040	40 A	Gul	
1569-16050	50 A	Sort	
1569-16060	60 A	Blå	
<b>HOVEDSIKRING</b>		<b>Pakn. à 5 stk</b>	
1569-08030	30 A		 <p style="text-align: right;">30mm</p> <p style="text-align: center;">Passer i 0100360</p>
1569-08040	40 A		
1569-08050	50 A		
1569-08060	60 A		
1569-08080	80 A		
1569-080100	100 A		
<b>MIDI VAL</b>		<b>Pakn. à 1 stk</b>	
0602030	30A		 <p style="text-align: right;">30mm</p> <p style="text-align: center;">Passer i 0100360</p>
0602040	40A		
0602050	50A		
0602060	60A		
0602080	80A		
0602100	100A		
0602125	125A		
0602150	150A		
0602200	200A		
<b>MEGA VAL</b>		<b>Pakn. à 1 stk</b>	
0601040	40 A		 <p style="text-align: right;">51mm</p> <p style="text-align: center;">Passer i 0100385</p> <p style="text-align: center;">Maks 32V</p>
0601060	60 A		
0601080	80 A		
0601100	100 A		
0601125	125 A		
0601150	150 A		
0601175	175 A		
0601200	200 A		
0601225	225 A		
0601250	250 A		
0601300	300 A		
0601400	400 A		
0601500	500 A		

For å se alle modeller eller andre strl., se hele vårt sortiment på [www.importex24.no](http://www.importex24.no)

## SIKRINGER

SIKRINGER ANL U/HUS		Pakn. à 1 stk
BEST.NR	AMP	
<b>0200579</b>	80A	
<b>0200580</b>	100A	
<b>0200582</b>	160A	
<b>0200583</b>	200A	
<b>0200584</b>	250A	
<b>0200585</b>	300A	
<b>0200586</b>	400A	
<b>0200587</b>	500A	
SIKRINGER ANL M/HUS		Pakn. à 1 stk
<b>1569-147100</b>	100 A	
<b>1569-147150</b>	150 A	
<b>1569-147200</b>	200 A	
<b>1569-147250</b>	250 A	
<b>1569-147300</b>	300 A	
<b>1569-147400</b>	400 A	
<b>1790-5137</b>	500 A	Blue Sea
<b>1790-5162</b>	675 A	Blue Sea
HOVEDSTRØM AUTOMATSIKRINGER		Pakn. à 1 stk
<b>1790-7183A</b>	50 A	
<b>1790-7184A</b>	60 A	
<b>1790-7186A</b>	80 A	
<b>1790-7187A</b>	100 A	

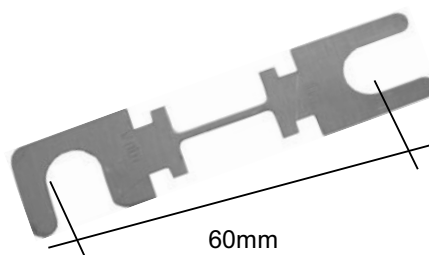



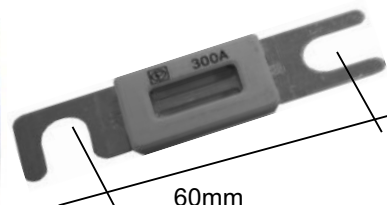





Passer i 1790-5005 og 1790-5503



Passer i 1790-5005 og 1790-5503

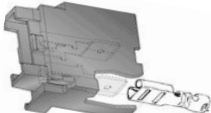

## SIKRINGSHOLDERE

SIKRINGSHOLDER FLATSTIKK NORM		
Best.nr.	Beskrivelse	
	Maks 20A. 1,3 kv. kabel / Sprutsikker.	
<b>1569-19030</b>	Maks 20A. 2,5 kv. kabel / Sprutsikker.	
<b>0100336</b>	Maks 30A. 4 kv. kabel / Sprutsikker.	
<b>1569-19047</b>	Maks 30A. 1,3 kv. kabel / 1 GM Mini. Sprutsikker	
<b>1569-19036</b>	Maks 15A. 1,3 kv. kabel / 1 til 2 GM Mini.	
<b>1569-19037</b>	Maks 15A. 2,5 kv. kabel / 1 til 2 GM.	
<b>0100351</b>	Maks 40A. Kan klipse flere på hverandre.	
<b>0100352</b>	Festeplate for 01.00351	
<b>0100359</b>	Lokk for 01.00351	

For å se alle modeller eller andre strl., se hele vårt sortiment på [www.importex24.no](http://www.importex24.no)



## SIKRINGSHOLDERE

SIKRINGSBOKSER FLATSTIKK		
Best.nr.	Ant. Sikringer	Beskrivelse
0100610	4	
0100600	6	
0100590	8	
SIKRINGSBOKSER FLATSTIKK		
Best.nr.	Beskrivelse	
1790-5025	6 faser m/ jord	
1790-5026	12 faser m/ jord	
1790-5029	12 faser u/ jord	

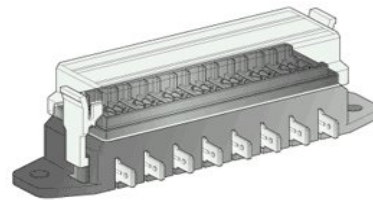
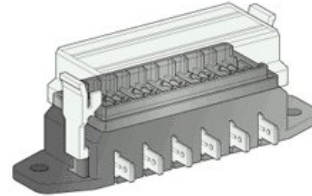
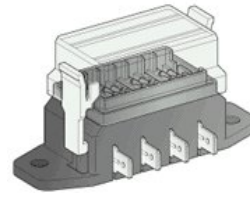

**BLUE SEA**  
SYSTEMS







**BLUE SEA**  
SYSTEMS



**BLUE SEA**  
SYSTEMS

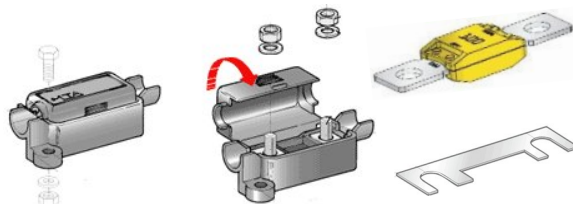
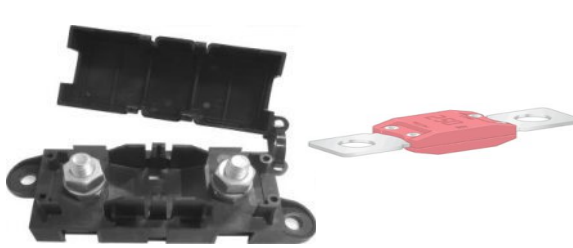











For å se alle modeller eller andre strl., se hele vårt sortiment på [www.importex24.no](http://www.importex24.no)

## SIKRINGSHOLDERE

SIKRINGSHOLDER HOVEDSIKRING		
Best.nr.	Beskrivelse	
<b>0100360</b>	Opp til 16kv. Kabel Boltavstand 30mm 37 x 70mm Maks 100A 5mm bolter m/ lokk	
<b>0100385</b>	Boltavstand 51mm Maks 32V / 300A MEGAVAL 8mm bolter m/ lokk	
SIKRINGSHOLDER ANL		
<b>1790-5005</b>	Blue Sea Boltavstand 61,7mm 38 x 115mm Maks 32V / 300A ANL 8mm bolter m/ lokk	 
<b>1790-5503</b>	Blue Sea Boltavstand 61,7mm 51 x 178mm Maks 32V / 750A ANL 8mm bolter m/ lokk	 



For å se alle modeller eller andre strl., se hele vårt sortiment på [www.importex24.no](http://www.importex24.no)

## KOBLINGSPUNKT

KOBLINGSPUNKT		
Best.nr.	Beskrivelse	
<b>1790-2002</b>	44 x 84mm. 8mm bolt. Maks 48V. Avstand mellom festebolter 635mm. Rustfritt stål.	 
<b>1790-2003</b>	44 x 84mm. 10mm bolt. Maks 48V. Avstand mellom festebolter 635mm. Rustfritt stål.	 
<b>1790-2019</b>	48 x 70mm 2 x 10mm bolter Maks 48V / 200A	 
<b>1790-2127</b>	38 x 149 x 49mm 4 x 8mm bolter Avstand mellom festebolter 181mm Maks 48V / 250A Rustfritt stål	 
<b>1790-2301</b>	32 x 146 x 37mm 2 x 6mm bolter 10 x 4mm skrutilkobling Avstand mellom festebolter 133mm Maks 48V / 150A, 300V / 130A Rustfritt stål	 
<b>1790-2723</b>	65,5 x 124 x 38mm 2 x 8mm bolter 5 x skrutilkobling (+) 5 x skrutilkobling (-) med beskyttelsesdeksel Maks 48V / 150A, 300V / 130A	 







For å se alle modeller eller andre strl., se hele vårt sortiment på [www.importex24.no](http://www.importex24.no)

## KOBLINGSBOKSER

KOBLINGSBOKSER		
Best.nr.	Beskrivelse	
<b>1000-1916</b>	6 Polet.	
<b>50290038</b>	8 polet. 8 flatstikk dobbelt.	
<b>1801-3500</b>	12 polet. 8 flatstikk dobbelt. 4 flatstikk tredobbelt.	
<b>1000-1913</b>	16 polet. 48 stikk. ADR	
<b>1000-1917</b>	16 polet. 48 stikk.	

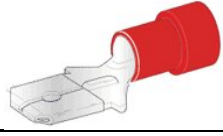
For å se alle modeller eller andre strl., se hele vårt sortiment på [www.importex24.no](http://www.importex24.no)

## KABELSKO

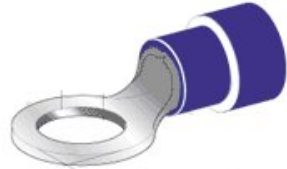
KABELSKO UISOLERTE				
Best.nr.	Dim. mm	Bredde mm.	Ant.	
1101650	0,5-2,5	6,3	100	
1101660	0,5-2,5	6,3	100	
KABELSKO ISOLERTE				
Best.nr.	Dim. mm	Bredde mm.	Farge / Ant.	
1850401	0,25-1,6	2,8	Rød/100	
1851001	0,25-1,6	6,3	Rød/100	
1855001	1-2,6	6,3	Blå/100	
1861001	2,6-6,6	6,3	Gul/50	
1863001	2,6-6,6	9,5	Gul/25	
1852001	0,25-1,6	6,3	Rød/100	
1856001	1-2,6	6,3	Blå/100	
1862001	2,6-6,6	6,3	Gul/50	
1851501	0,25-1,6	6,3	Rød/50	
1855501	1-2,6	6,3	Blå/50	
1860501	2,6-6,6	6,3	Gul/25	
1860600	2,6-6,6	9,5	Gul/50	
1852401	0,25-1,6	6,3	Rød/50	
1856401	1-2,6	6,3	Blå/50	
1852501	0,25-1,6	6,3	Rød/50	
1862501	1-2,6	6,3	Blå/50	
1853051	0,25-1,6	3,0	Rød/100	
1853071	0,25-1,6	4,3	Rød/100	
1853151	0,25-1,6	5,3	Rød/100	
1853201	0,25-1,6	6,0	Rød/50	
1853251	0,25-1,6	8,4	Rød/100	
1853350	0,25-1,6	10,0	Rød/100	
1857101	1-2,6	4,3	Blå/100	
1857151	1-2,6	5,3	Blå/100	
1857201	1-2,6	6,5	Blå/50	
1857251	1-2,6	8,4	Blå/50	
1857350	1-2,6	10,0	Blå/50	
1863151	2,6-6,6	5,3	Gul/50	
1863201	2,6-6,6	6,5	Gul/50	
1863251	2,6-6,6	8,4	Gul/25	
1863301	2,6-6,6	10,5	Gul/25	

For å se alle modeller eller andre strl., se hele vårt sortiment på [www.importex24.no](http://www.importex24.no)



## KABELSKO

KABELSKO ISOLERTE			
Best.nr.	Dim. mm	Bredde.mm	Farge / Ant.
1868001	0,25-1,6	Skjøt	Rød/100
1868101	1-2,6	Skjøt	Blå/50
1868201	2,6-6,6	Skjøt	Gul/25
1864101	0,25-1,6	4mm hull	Rød/50
1864601	1-2,6	5mm hull	Blå/50
1864001	0,25-1,6	4mm hull	Rød/100
1864501	1-2,6	5mm hull	Blå/50
SCOTCHLOK KOBL. KLEMME			
Best.nr.	Dim. mm	Farge / Ant.	
1569-20025	0,5-1,6	Rød/10	
1569-20026	1,0-2,6	Blå/10	
LYSTERKLEMMER / SUKKERBITER			
Best.nr.	Beskrivelse		
4430100	Lysterklemmer/sukkerbiter. 2,5mm <sup>2</sup> .		
4430110	Lysterklemmer/sukkerbiter. 6,0mm <sup>2</sup> .		
4430120	Lysterklemmer/sukkerbiter. 10,0mm <sup>2</sup> .		
4430130	Lysterklemmer/sukkerbiter. 16,0mm <sup>2</sup> .		
KABELSKO ASSORTEMENT			
Best.nr.	Inneholder		
1860004	18 forskjellige, totalt 705 stk. 9 typer røde. 9 typer blå.		
1569-20050	18 forskjellige, totalt 150 stk. 8 typer røde. 9 typer blå. 1 type gule.		
54254161	Uisolerte kabelsko. 30 forskjellige sko. Totalt 750stk. 2 forskjellige gummihylser. Totalt 50 stk.		



For å se alle modeller eller andre strl., se hele vårt sortiment på [www.importex24.no](http://www.importex24.no)

## KABELSKO

KRYMPE			
Best.nr.	Dim. mm.	Bredde mm.	Farge / Stk.
1880341	0,5-1,5	6,3	Rød/50
1880351	1,5-2,5	6,3	Blå/25
1880361	4,0-6,0	6,3	Gul/25
1880281	0,5-1,5	6,3	Rød/50
1880291	1,5-2,5	6,3	Blå/50
1880331	4,0-6,0	6,3	Gul/25
KRYMPE			
1880031	0,5-1,5	6,0	Rød/50
1880081	1,5-2,5	6,0	Blå/50
1569-20069	1,5-2,5	8,0	Blå/5
1880131	4,0-6,0	6,0	Gul/25
1880141	4,0-6,0	8,0	Gul/25
KRYMPESKJØT M/ LIM			
1569-20018	0,5-1,5		Rød/10
1980232	0,5-1,5		Rød/50 Duraseal
1569-20019	1,5-2,5		Blå/100
1980242	1,5-2,5		Blå/50 Duraseal
1569-20020	4,0-6,0		Gul/100
1980252	4,0-6,0		Gul/25 Duraseal
KRYMPESKJØT M/ LODDING OG LIM			
1569-20021	0,2-0,7		Klar/10
1569-20022	0,5-1,5		Rød/10
1569-20023	1,5-2,5		Blå/10
1569-20024	3,5-6,0		Gul/10
KRYMPESKJØT ASSORTEMENT			
Best.nr.	Inneholder		
1569-20052	4 forskjellige, totalt 70 stk. 10stk. Blank 0,2 - 0,5mm. 25stk. Rød 0,5 - 1,5mm. 25stk. Blå 1,5 - 2,5mm. 10stk. Gul 4 - 6mm.		

LODDETINN	
Best.nr.	Beskrivelse
4209050	Tykkelse: 2mm. / Vekt: 500g.



For å se alle modeller eller andre strl., se hele vårt sortiment på [www.importex24.no](http://www.importex24.no)

## KABELSKO

STARTKABELSKO			
Best.nr.	Mål	Ant.	Lengde mm.
CTT06/06	6Kv - hull Ø 6mm.	10	
CTT06/08	6Kv - hull Ø 8mm.	10	
CTT10/06	10Kv - hull Ø 6mm.	10	
CTT10/06L	10Kv - hull Ø 6mm.	10	30
CTT10/08	10Kv - hull Ø 8mm.	10	
CTT10/08L	10Kv - hull Ø 8mm.	10	35
CTT10/10	10Kv - hull Ø 10mm.	10	
CTT10/10L	10Kv - hull Ø 10mm.	10	39
CTT16/06	16Kv - hull Ø 6mm.	10	
CTT16/06L	16Kv - hull Ø 6mm.	10	39
CTT16/08	16Kv - hull Ø 8mm.	10	
CTT16/08L	16Kv - hull Ø 8mm.	10	38
CTT16/10	16Kv - hull Ø 10mm.	10	
CTT16/10L	16Kv - hull Ø 10mm.	10	42
CTT25/06	25Kv - hull Ø 6mm.	10	
CTT25/06L	25Kv - hull Ø 6mm.	10	40
CTT25/08	25Kv - hull Ø 8mm.	10	
CTT25/08L	25Kv - hull Ø 8mm.	10	40
CTT25/10	25Kv - hull Ø 10mm.	10	
CTT25/10L	25Kv - hull Ø 10mm.	10	44
CTT35/06	35Kv - hull Ø 6mm.	10	
CTT35/06L	35Kv - hull Ø 6mm.	10	41
CTT35/08	35Kv - hull Ø 8mm.	10	
CTT35/08L	35Kv - hull Ø 8mm.	10	41
CTT35/10	35Kv - hull Ø 10mm.	10	
CTT35/10L	35Kv - hull Ø 10mm.	10	45
CTT35/12	35Kv - hull Ø 12mm.	10	
CTT35/12L	35Kv - hull Ø 12mm.	10	45
CTT50/08	50Kv - hull Ø 8mm.	10	
CTT50/08L	50Kv - hull Ø 8mm.	10	46
CTT50/10	50Kv - hull Ø 10mm.	10	
CTT50/10L	50Kv - hull Ø 10mm.	10	50
CTT50/12	50Kv - hull Ø 12mm.	10	
CTT50/12L	50Kv - hull Ø 12mm.	10	50
CTT70/08	70Kv - hull Ø 8mm.	10	
CTT70/08L	70Kv - hull Ø 8mm.	10	48
CTT70/10	70Kv - hull Ø 10mm.	10	
CTT70/10L	70Kv - hull Ø 10mm.	10	52
CTT70/12	70Kv - hull Ø 12mm.	10	
CTT70/12L	70Kv - hull Ø 12mm.	10	50
CTT95/10	95Kv - hull Ø 10mm.	10	
CTT95/10L	95Kv - hull Ø 10mm.	10	58
CTT95/12	95Kv - hull Ø 12mm.	10	
CTT92/12L	95Kv - hull Ø 12mm.	10	58
CTT120/10	120Kv - hull Ø 10mm.	10	
CTT120/12	120Kv - hull Ø 12mm.	10	



SKJØTEHYLSER		
Best.nr.	Mål	Ant.
CTB10	10 Kv	10
CTB16	16 Kv	10
CTB25	25 Kv	10
CTB35	35 Kv	10
CTB50	50 Kv	10
CTB70	70 Kv	10
CTB95	95 Kv	10
CTB120	120 Kv	10



For å se alle modeller eller andre strl., se hele vårt sortiment på [www.importex24.no](http://www.importex24.no)





## POLSKO OG STARTKABEL KLYPER

POLSKO		
Best.nr.	Beskrivelse	
RACO203 RACO204	Polsko "PLUS" CuZn. 25-50mm <sup>2</sup> Polsko "MINUS" CuZn. 25-50mm <sup>2</sup>	
RACO227V RACO228V	Polsko "PLUS" CuZn. m/10mm vingemutter Polsko "MINUS" CuZn. m/10mm vingemutter	
RACO227 RACO228 RACO229 RACO230	Polsko "PLUS" m/10mm mutter Polsko "MINUS" m/10mm mutter Polsko "PLUS" m/8mm mutter Polsko "MINUS" m/8mm mutter	
RACO239 RACO240	Polsko "PLUS" m/dobbel klammer 50-70mm <sup>2</sup> Polsko "MINUS" m/dobbel klammer 50-70mm <sup>2</sup>	
1556-190200	Polsko for hurtigmontering. Leveres i par, rød/blå.	
GUMMIHETTER		Pakn. à 10 stk.
Best.nr.	Beskrivelse	
AC1	Gummiheite 6/ 11mm.	
AC2	Gummiheite 7.5/ 15mm.	
AC3	Gummiheite 9/ 15mm.	
AC4	Gummiheite 17/ 27mm.	
POLSKOHETTER		Pakn. à 10 stk.
Best.nr.	Beskrivelse	
BTC20B	Sort PVC 35x48x25mm	 BTC20      BTC50
BTC20R	Rød PVC 35x48x25mm	
BTC50B	Sort PVC 62x35x28mm	
BTC50R	Rød PVC 62x35x28mm	
STARTKABEL KLYPER		
Best.nr.	Beskrivelse	
RACO901 RACO902	Rød. Maks 500A. Sort. Maks 500A. For 25-50kv. Kabel.	
RACO905 RACO906	Rød. Maks 850A. Sort. Maks 850A. For 25-50kv. Kabel.	
1560-1417PUN 1560-1417MUS	Rød. Maks 1000A. Sort. Maks 1000A.	

For å se alle modeller eller andre strl., se hele vårt sortiment på [www.importex24.no](http://www.importex24.no)



## KABELSKOTENGER

KABELSAKS/ KABELTANG		
Best.nr.	Beskrivelse	
TT50	Kabelsaks 0-70Kv.	
TT308	For alle typer isolerte kabelsko: Rød, blå, gul, med og uten lim. Tangen sikrer at man får riktig krymping før den løser ut.	
1716-601138	For alle typer isolerte kabelsko: Rød, blå, gul, med og uten lim. Spesielt godt egnet for tynnvegget kabel i små dimensjoner. Tangen sikrer at man får riktig krymping før den løser ut.	
1714-V2499	Profesjonell kabelskotang med 5stk. utskiftbare "kjefter". For uisolerte sko til kabel fra 1,5 til 10Kv. For isolerte sko til kabel fra 0,5 til 6Kv. Leveres i plastkoffert.	
9602490	Startkabelsko tang 10-120Kv.	

For å se alle modeller eller andre strl., se hele vårt sortiment på [www.importex24.no](http://www.importex24.no)

## KRYMPE /- KABELSTRØMPE

KABELSTRØMPE			
Best.nr.	Innvendig dia.	Lengde / Farge	
PVC-2200701	7mm	100m / Sort	
PVC-2201001	10mm	100m / Sort	
PVC-2201601	16mm	100m / Sort	
PVC-2202201	22mm	50m / Sort	
KRYMPESTRØMPE / KRYMPE 2 TIL 1			
Best.nr.	Innvendig dia.	Lengde / Farge	
02472001	3,2mm	15m / Sort	
024720260	4,8mm	10m / Sort	
024720261	4,8mm	10m / Rød	
024720280	6,4mm	10m / Sort	
024720281	6,4mm	10m / Rød	
024720300	9,5mm	10m / Sort	
024720301	9,5mm	10m / Rød	
024720320	12,7mm	5m / Sort	
024720321	12,7mm	5m / Rød	
024720340	19,0mm	5m / Sort	
024720341	19,0mm	5m / Rød	
KRYMPESTRØMPE MED LIM / KRYMPE 2 TIL 1			
024730203	3mm	3,5m / Sort	
024730206	6mm	3,5m / Sort	
024730209	9mm	3,0m / Sort	
024730212	12mm	2,5m / Sort	
024730218	18mm	2,0m / Sort	
024730224	24mm	1,5m / Sort	
KRYMPESTRØMPE / KRYMPE 2 TIL 1			
Best.nr.	Beskrivelse	Innvendig dia.	Ant.
1569-20054	Ass. med 170stk. Sorte.	1,6mm	60
		2,4mm	40
		3,2mm	30
		4,8mm	20
		6,4mm	10
		9,5mm	10
KRYMPESTRØMPE / KRYMPE 2 TIL 1			
Best.nr.	Innvendig dia.	Lengde / Farge	
1569-19066	2,4mm	2m / Sort	
1569-19067	3,2mm	2m / Sort	
1569-19068	4,8mm	2m / Sort	
1569-19069	6,4mm	2m / Sort	
1569-19070	9,5mm	2m / Sort	
1569-19071	12,7mm	2m / Sort	
1569-19072	19,1mm	2m / Sort	
STATIV FOR KRYMPESTRØMPE			
Best.nr.	Innvendig dia.	Lengde / Farge	
024720400		Stativ for krympestrømper / 6 bokser. Mål: 325x200x170mm.	

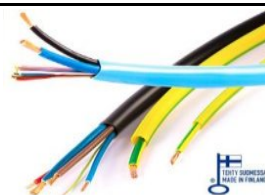

For å se alle modeller eller andre strl., se hele vårt sortiment på [www.importex24.no](http://www.importex24.no)



## TAPE / TEIP

TAPE/TEIP		Pakn. à 10 stk.
Best.nr.	Beskrivelse	
<b>1710-IB1510</b> <b>1710-IR1510</b>	Isolasjonstape, sort. Ruller à 10m. Isolasjonstape, rød. Ruller à 10m.	
<b>1710-DC5050</b>	Sølvfarget universaltape. Maks temperatur: 75°C Bredde:48. Tykkelse: 0,17mm. Lengde: 50m.	
<b>1710-CS5025</b>	Grå universaltape. Meget sterk, strekkfasthet:183N / Limstyrke: 13N/25mm. Vanntett og værbestandig. Maks temperatur: 80°C Bredde:48. Tykkelse: 0,3mm. Lengde: 25m.	
<b>1710-CB5025</b>	Sort universaltape. Meget sterk, strekkfasthet:183N / Limstyrke: 13N/25mm. Vanntett og værbestandig. Maks temperatur: 80°C Bredde:48. Tykkelse: 0,3mm. Lengde: 25m.	
<b>1710-HW5033</b>	Gul/Sort sikkerhets tape. Ekstra slitesterk, egner seg for markering på gulv. Maks temperatur: 80°C Bredde:50. Tykkelse: 0,19mm. Lengde: 33m.	
<b>1606-16001</b>	Reflextape UN / ECE - 104. Klasse C. Bredde:50,8. Lengde 50m.	
<b>1606-16006</b>	Reflextape Fleksibel for bruk på myke underlag. F.eks presenning. UN / ECE - 104. Klasse C. Bredde:50,8. Lengde 50m.	

For å se alle modeller eller andre strl., se hele vårt sortiment på [www.importex24.no](http://www.importex24.no)

## FESTEMATERIELL

STRIPS			
Best.nr.	Dimm. (l x b)	Farge	Ant
1111-01910	100 x 2,5	Sort	100
1111-03011	150 x 3,5	Sort	100
1111-04890	200 x 4,6	Sort	100
1111-00222	300 x 4,6	Sort	100
1111-12032	390 x 7,6	Sort	100
1111-60501	535 x 13,2	Sort	50
FESTE FOR STRIPS			
Best.nr.	Dim. (l x b)	Farge	Ant
1111-28412	28x28x4,7	Sort	100
For strips bredde opp til 5,4mm. Med tape og festehull.			
<b>CMA1406</b>	10x20	Sort	100
For strips med bredde opp til 5mm. Med festehull for skru montering.			
<b>CMA1405</b>	20X22	Sort	100
For strips med bredde opp til 9mm. Med festehull for skru montering.			



HellermannTyton



HellermannTyton



## FESTEMATERIELL

FESTE KLAMMER			
Best.nr.	Innvendig dia.	Bredde	Ant.
PA50	4,8mm	12,7mm	10
PA51	6,0mm	12,7mm	10
1712-112008	8,0mm	12,7mm	10
1712-112010	10,0mm	12,7mm	10
1712-112011	12,0mm	12,7mm	10
1712-112013	13,0mm	12,7mm	10
1712-112014	14,0mm	12,7mm	10
1712-112016	16,0mm	12,7mm	10
1712-112017	17,0mm	12,7mm	10
1712-112019	19,0mm	12,7mm	10
1712-112025	25,0mm	12,7mm	10

B = 6,2mm

**Zink belagt stål med gummi beskyttelse. Brukes for å feste kabler og rør.**

FESTE KLAMMER			
Best.nr.	Innvendig dia.	Bredde	Ant.
CMA1000	3,2mm	9,7mm	50
CMA1001	4,8mm	9,7mm	50
CMA1002	6,35mm	9,7mm	50
CMA1003	7,9mm	9,7mm	50
CMA1004	9,5mm	9,7mm	50
CMA1005	12,7mm	12,0mm	50
CMA1006	15,8mm	12,0mm	50
CMA1007	19,4mm	12,0mm	50
CMA1008	25,4mm	12,0mm	50



PLASTRØR FOR BESKYTTELSE AV KABEL			
Best.nr.	Innv. dia. / Utv. Dia.	Farge	Lengde
1090-016310-1	10x12,6mm	Sort	50m
1090-016311-1	12,6x18,9mm	Sort	50m
1090-01632-1	16,5x20,9mm	Sort	50m
1090-01633-1	21,2x25,5mm	Sort	50m



Kabelbeskyttelse FFPYL-MOD-BS HALK, FMVSS 302, UL 94 HB.  
Temp.: -40°C -> +135°C.

1090-01603-1	8,6x11,5mm	Sort	50m
1090-01604-1	10,0x12,8mm	Sort	50m
1090-01605-1	12,9x16mm	Sort	50m



Halogenfri, flammehemmende og selvslukkende materiale.  
Røret er meget slitesterkt og tåler bensin, diesel, olje, fett, mm.  
Beskyttelse: PA6, FPMYD-L, FMVSS 302, UL 94 V2. ADR.  
Temp.: -40°C -> +120°C.

**T og Y koblinger leveres på forespørsel**

For å se alle modeller eller andre strl., se hele vårt sortiment på [www.importex24.no](http://www.importex24.no)

## HOVEDSTRØMBRYTERE

HOVEDSTRØMBRYTERE		
Best.nr.	Tekn. data	
1569-20129	<p>24V/500A i 10 sek. / 100A kont.                      Beskyttelsesgrad: IP43.                      Arbeidstempratur: -40C / +50C.                      8mm. bolter.  <b>Reservenøkkel: 51542</b></p>	
290000	<p>Vannbeskyttet med støvhette.                      Maks: 24V/500A i 5 sek. / 100A kont.                      10mm. bolter.</p>	
1000-0023PAL	<p>Maks: 24V/1000A i 5 sek.                      Kontinuerlig: 12V/100A - 24V /75A.                      Diameter: 65mm.                      10mm. Bolter.                      Med avtagbar nøkkel.</p>	
290025	<p>Spesielt kraftig utførelse                      Maks: 24V/2500A i 5 sek. / 250A kont.                      10mm. bolter.</p>	
1000-003799	<p>Vannbeskyttet stål med støvhette.                      Maks: 24V/2500A i 5 sek. / 250A kont.                      Beskyttelsesgrad: IP67 / ISO1106.                      Arbeidstempratur: -40C / +80C.                      10mm. bolter.</p>	

For å se alle modeller eller andre strl., se hele vårt sortiment på [www.importex24.no](http://www.importex24.no)



## HOVEDSTRØMBRYTERE

HOVEDSTRØMBRYTERE		
Best.nr.	Tekn. data	
<b>1000-0067</b>	<p>Spesielt kraftig bryter for båter og anleggsmaskiner etc. Maks: 24V/2500A i 3 sek. / 250A kont. 10mm. bolter.</p>	
<b>1000-0096</b>	<p>Vannbeskyttet stål med støvhette. 2-Polet bryter. Maks: 24V/2500A i 5 sek. / 250A kont. Beskyttelsesgrad: IP65. Arbeidstemperatur: -40C / +80C. 10mm. bolter.</p>	
<b>1000-008313</b>	<p>Bryter med AV-PÅ funksjon. Maks: 24V/1000A i 5 sek. / 300A kont. Beskyttelsesgrad: IP54. L: 69mm / B: 77mm. / H: 69mm. 2 x 10mm. bolter.</p>	
<b>1000-0085</b>	<p>Bryter med: AV - 1 - 1+2 -2 funksjon. Maks: 24V/1000A i 5 sek. / 300A kont. Beskyttelsesgrad: IP54. L: 69mm / B: 77mm. / H: 69mm. 3 x 10mm. bolter.</p>	
<b>1800-024</b>	<p>Bryter med: AV - 1 - 1+2 -2 funksjon. Kontinuerlig: 50V/200A. Diameter: 140mm. 8mm. bolter.</p>	
 <b>1790-6011</b>	<p>Bryter med: AV - 1 - 1+2 funksjon. Maks: 32V/1000A i 10 sek. Kontinuerlig: 32V/300A. Beskyttelsesgrad: IP66, SAE J1171 Mål: 70 x 70mm. 10mm. bolter.</p>	

For å se alle modeller eller andre strl., se hele vårt sortiment på [www.importex24.no](http://www.importex24.no)









## HOVEDSTRØMBRYTERE

<b>HOVEDSTRØMBRYTERE</b>		
Best.nr.	Tekn. data	
 <b>1790-5511E</b>	Bryter med: AV - 1 - 1+2 funksjon. Maks: 32V/1000A i 10 sek. Kontinuerlig: 32V/350A. Beskyttelsesgrad: IP66, SAE J1171 Mål: 98 x 98mm. 10mm. bolter.	
 <b>1790-6005</b>	Bryter med: AV - PÅ funksjon. Maks: 48V/1500A i 10 sek. Kontinuerlig: 48V / 300A Har avtagbar nøkkel. Beskyttelsesgrad: IP66, SAE J1171 Mål: 72 x 72mm. 3 x 10mm. bolter. For montering under panel ø67. Avstand mellom festehull; 55mm.	
 <b>1790-6006</b>	Bryter med: AV - PÅ funksjon. Maks: 48V/1500A i 10 sek. Kontinuerlig: 48V/300A. Beskyttelsesgrad: IP66, SAE J1171 Mål: 72 x 72mm. 3 x 10mm. bolter. For montering under panel ø67. Avstand mellom festehull; 55mm.	
<b>ELEKTRISKE HOVEDSTRØMBRYTERE</b>		
<b>1100-9460</b> <b>1100-9450</b>	Elektrisk styrt. 12V / 1 Polet. Elektrisk styrt. 24V / 1 Polet. Maks: 2500A i 5 sek. / 250A kont. Beskyttelsesgrad: IP65 / IPX7. Arbeidstemperatur: -40C / +85C. 10mm. bolter. Gummihetter for kabler medfølger!	
<b>1100-9660</b>	Elektrisk styrt. 24V / 2 Polet. Maks: 2500A i 5 sek. / 250A kont. Beskyttelsesgrad: IP65 / IPX7. Arbeidstemperatur: -40C / +85C. 10mm. bolter. Gummihetter for kabler medfølger!	

For å se alle modeller eller andre strl., se hele vårt sortiment på [www.importex24.no](http://www.importex24.no)



## TENNINGSBRYTERE

TENNINGLÅS		
Best.nr.	Tekn. data	
327300	Tenningslås. Pos.: Park- O - Tenning - Start. Hull: 19mm.	
327550	Plast versjon med samme funksjoner som 327300 Hull: 20mm	
0342309003	Pos.: Park- O - Tenning - Start. Hull: 22 x 11mm. <b>Orginal Bosch.</b>	
1000-02012	Tenningslås m/ gløding, 3 stikk. Pos.: Glød - O - Start. Leveres med 1 nøkkel m/hette. Hull: 16mm. <b>Løs nøkkel: EC47080</b>	
1000-0051-16mm	Tenningslås m/ gløding, 4 stikk. Pos.: Park- O - Glød - Start. Leveres med 2 nøkler. Hull: 16mm. <b>Løs nøkkel: EC47080</b>	
1000-0044	Tenningslås m/ gløding i marineutførelse. Pos.: Park- O - Tenning - Glød - Start. Hull: 26mm.	
0342315001	Pos.: O - Tenning - Glød - Start. Hull: 22 x 11mm. <b>Orginal Bosch.</b>	

For å se alle modeller eller andre strl., se hele vårt sortiment på [www.importex24.no](http://www.importex24.no)

## BRYTERE

BRYTERE		
Best.nr.	Beskrivelse	
<b>29-1103</b>	For 15mm hull. Plast med skrutilkoblinger.	
<b>200220</b>	Vanntett. For 22mm hull. Kan også brukes uten gummihette.	
<b>MERIT-210020</b>	Kort stamme, sort. Knapp=Ø14mm	
<b>230200</b>	Lang stamme, sort. Knapp=Ø14mm MAX:24V/16A/150W Skrutilbobling	
<b>1000-0024</b>	12 / 24V. Av / På. 2 flatstikk. For 12mm. monteringshull.	
<b>1569-20118</b>	12 / 24V. På / Av / På. Fjærbelastet retur til AV. 3 flatstikk. For 12,2mm monteringshull.	
<b>1569-30231</b>	12 / 24V. For nærløys, Av / På. Har innebygd blått LED lys. 3 flatstikk. For 20mm monteringshull.	
<b>1569-30234</b>	12 / 24V. For arbeidslys, Av / På. Har innebygd rødt LED lys. 3 flatstikk. For 20mm monteringshull.	
<b>1569-30233</b>	12 / 24V. For varselløys, Av / På. Har innebygd rødt LED lys. 3 flatstikk. For 20mm monteringshull.	
<b>1000-0045</b>	12 / 24V. Varmeapparat bryter, Av / På. Med 3 trinn. 3 flatstikk. For 12mm monteringshull.	

For å se alle modeller eller andre strl., se hele vårt sortiment på [www.importex24.no](http://www.importex24.no)

## BRYTERE

BRYTERE BLUE SEA	
Best.nr.	Beskrivelse
<b>1790-8230</b>	Vanntett bryter med AV/PÅ funksjon. 12V / 20A - 24V / 15A. Med LED indikartor. Monteringshull: 21,1 x 36,8mm. Utv. Mål: 24,5 x 48,5mm.

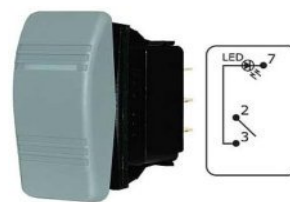

**BLUE SEA SYSTEMS**

**Brytere med andre funksjoner kan skaffes på forespørsel.**

<b>1790-7902</b>	Symbolsett for 1790-8230. 18 alternative klistremerker.	
<b>1790-8268</b>	Installeringsramme for 1 bryter. Utv. Mål: 58 x 34mm.	
<b>1790-8259</b>	Installeringsramme for 3 bryter. Utv. Mål: 58 x 87mm.	
<b>1790-8260</b>	Installeringsramme for 6 bryter. Utv. Mål: 58 x 165mm.	
<b>1790-8267</b>	Installeringsramme for bygging av ramme med 2 stk. 1790-8267 og antall 1790-8266 etter eget ønske. Monteringshull: 25 x 48,5mm.	
<b>1790-8266</b>	Installeringsramme for bygging av egen ramme med antall 1790-8266 etter eget ønske og 2 stk. 1790-8267 som ender. Monteringshull: 25 x 48,5mm.	



**For å se alle modeller eller andre strl., se hele vårt sortiment på [www.importex24.no](http://www.importex24.no)**

## BRYTERE

BRYTEREPANEL		
Best.nr.	Beskrivelse	
<b>1800-0255LED</b>	<p style="text-align: center;">12V. Sort plastpanel med 4 sprutsikre brytere og LED indikator lys. Leveres med 2 sikringsbokser. Mål: 95 x 107mm.</p>	
<b>1800-0253LED</b>	<p style="text-align: center;">12V. Sort plastpanel med 5 sprutsikre brytere, LED indikator lys og strømuttak. Leveres med 3 sikringsbokser. Mål: 95 x 107mm.</p>	
<b>1800-0240301</b>	<p style="text-align: center;">12V. Auto / Off / Manuell. Mal: 88 x 118mm.</p>	
KONTROLL LAMPE		
Best.nr.	Beskrivelse	
<b>738000</b>	Blått glass. For 17mm hull	
<b>738200</b>	Gult glass. For 17mm hull.	
<b>738400</b>	Grønt glass. For 17mm hull.	
<b>738600</b>	Rødt glass. For 17mm hull	
<b>12913</b>	Pære for kontroll lampe 12V.	
<b>13913</b>	Pære for kontroll lampe 24V.	

For å se alle modeller eller andre strl., se hele vårt sortiment på [www.importex24.no](http://www.importex24.no)

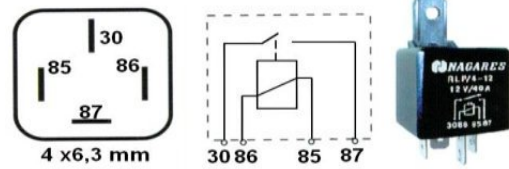
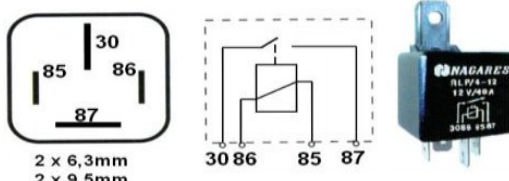
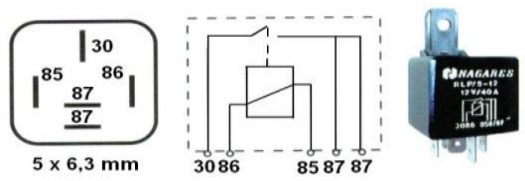
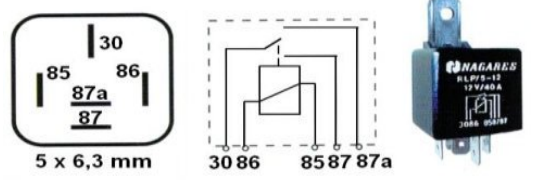
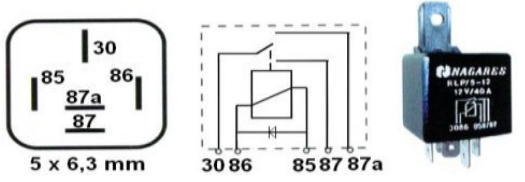
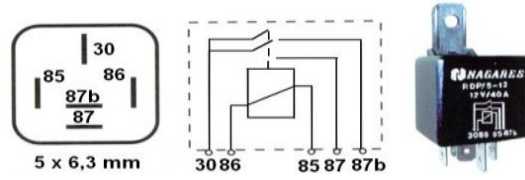
## RELEER

MINIRELEER			
Best.nr	Tekn. data	Mål	
<b>1100-0596U</b> <b>20200100</b> <b>20200100N</b> <b>20400100</b> <b>20400100N</b>	6V/40A 12V/30A, Wehrle 12V/40A, Nagares 24V/20A 24V/22A, Nagares	25x25x21,5mm 25x25x21,5mm 25x25x21,5mm 25x25x21,5mm 25x25x21,5mm	 <p>4 x 6,3 mm</p>
<b>22200111N</b> <b>22200117</b> <b>22400111N</b> <b>22400111-70</b> <b>22400119</b>	12V/70A, Nagares 12V/70A, Wehrle 24V 40A, Nagares 24V/70A, Nagares 24V/40A m/diode, Nagares	26,5x26,5x25mm 26,5x26,5x25mm 26,5x26,5x25mm 26,5x26,5x25mm 26,5x26,5x25mm	 <p>2 x 6,3mm 2 x 9,5mm</p>
<b>20207100</b> <b>20207100N</b> <b>20407100N</b>	12V/30A, Wehrle 12V/40A, Nagares 24V/20A, Nagares	25x25x21,5mm 25x25x21,5mm 25x25x21,5mm	 <p>5 x 6,3 mm</p>
<b>20201100</b> <b>20201100N</b> <b>20401100</b> <b>20401100N</b>	12V/20A/30A, Wehrle 12V/15A/40A, Nagares 24V/10A/20A, Wehrle 24V/10A/22A, Nagares	25x25x21,5mm 25x25x21,5mm 25x25x21,5mm 25x25x21,5mm	 <p>5 x 6,3 mm</p>
<b>20201103</b> <b>20201103N</b> <b>20401103</b> <b>20401103N</b>	12V/20A/30A m/diode 12V/15A/40A m/diode 24V/10A/20A m/diode 24V/10A/22A m/diode	27x27x25mm 27x27x25mm 27x27x25mm 27x27x25mm	 <p>5 x 6,3 mm</p>
<b>21203100</b>	12V 2x20A, Nagares	25x25x21,5mm	 <p>5 x 6,3 mm</p>
<b>10485008</b> <b>10700005</b>	For minirelè For 22200111, 22400111		

For å se alle modeller eller andre strl., se hele vårt sortiment på [www.importex24.no](http://www.importex24.no)



## RELEER

### Relè BOSCH 12V/75A - 24V/50A

**0332002156**  
12V / 75A

**0332002256**  
24V / 50A



Ved ønske om koblings skinner,  
se side 13.

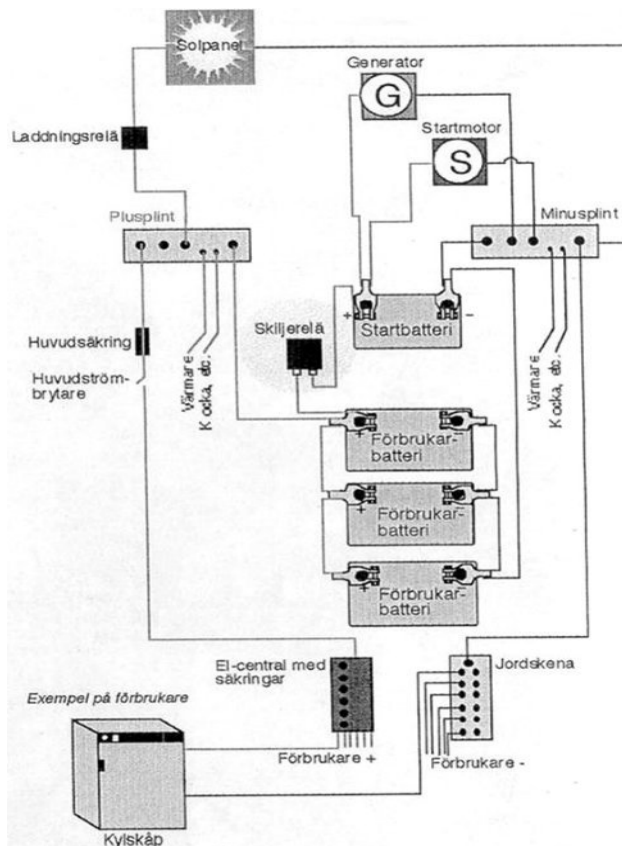

### Relè 12V/180 Amp. - 24V/ 80 Amp.

**1100-0509**

12V / 180A (start, 8 sekunder.)  
100A kontinuerlig.  
2x6mm. bolter + 2x6,3mm. stikk.

**1100-0510**

24V / 80A (start, 8 sekunder.)  
60A kontinuerlig.  
2x6mm. bolter + 2x6,3mm. stikk.

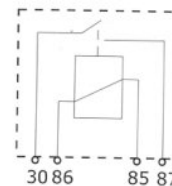
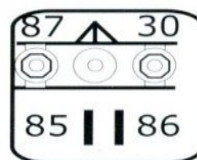

### Relè 12V/200Amp. - 24V/ 100 Amp.

**1100-0464**

12V / 200A (start, 8 sekunder.)  
120A kontinuerlig.  
2x6mm. bolter + 2x6,3mm. stikk.

**1100-03144**

24V / 120A (start, 8 sekunder.)  
100A kontinuerlig.  
2x6mm. bolter + 2x6,3mm. stikk.

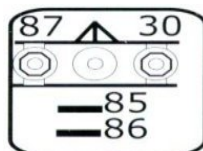

For å se alle modeller eller andre strl., se hele vårt sortiment på [www.importex24.no](http://www.importex24.no)



## RELEER

### Relè 12V/300 Amp. - 24V/ 200 Amp.

<b>1100-03044</b>	12V / 300A 600 Amp. start 8 sekunder. 300 Amp. kontinuerlig TREKK: 1A / HOLD: 0,37A
-------------------	--



<b>1100-03045</b>	24V / 200 A 400 Amp. start 8 sekunder. 200 Amp. kontinuerlig TREKK: 2A / HOLD: 0,5A
-------------------	--



### Skille relè 12V/100 Amp. - 24V/ 60 Amp.

<b>RDT/3-12</b>	12V / 100A
<b>RDT/3-24</b>	24V / 60A

Dette styrer seg selv.  
Når alternator begynner å lade  
åpner det til forbruksbatteri.

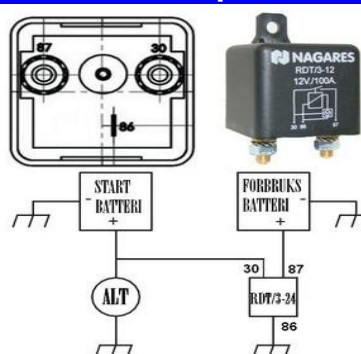

### Skille relè 12V/ 140 Amp.

<b>1100-03079</b>	12V / 140A. Åpner 13,3V / Lukker 12,8V Dette styrer seg selv!
-------------------	---













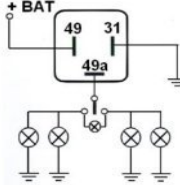

### Skille relè 12V-24V/ 120 Amp.

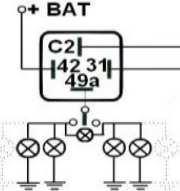
<b>1100-0445</b>	12V / 24V. Brukes på alternatorer som lader inntil 120A. Kan belastes med 210A i 5 min. Beskyttelsesgrad: IP67, SAE J1171
------------------	--

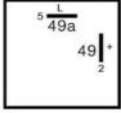

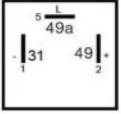
For å se alle modeller eller andre strl., se hele vårt sortiment på [www.importex24.no](http://www.importex24.no)

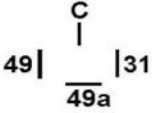
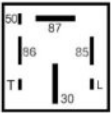
## RELEÈR

BLINKRELEÈR			
Best.nr	Tekn. data	Orginal nr.	
1100-0548	12V / 3-polet. Elektronisk universal modell. HD13.		 
54237001	12V 2/4x21W Lav modell, høyde 30mm.	Bosch: 335 200 038 Hella: 4DB002 895-011 4DB002 895-012 Wehrle: 54 201 001	 
54201103	12V 2/6x21W	Bosch: 335 200 041 Hella: 4DM003 360-001 4DM003 360-002 4DM003 390-003 Wehrle: 54 201 003	 
1569-20143	12V / 30W / 2-polet For LED pærer		 
1100-0461	12V / 30W / 3-polet For LED pærer		 
54401102		Bosch: 335 200 078 Hella: 4DB009123031 4DM003390031 Wehrle: 54201102	 
GLØDERELE			
1100-0448	12V Ford Opel Lombardini Fox serie	Wehrle: 51233008	 

For å se alle modeller eller andre strl., se hele vårt sortiment på [www.importex24.no](http://www.importex24.no)

## RELEER

HOVEDSTRØMS RELEER		
Best.nr.	Tekn. data	
4115-233954	12V / 1P. m/ startknapp. 8mm bolter.	
4115-5511	12V / 2P. 8mm bolter.	
4100-5794	12V / 2P. 800A (5 sek.) / 200A (kont). 8mm bolter / 2 flatstikk	
4100-5551	12V / 2P. 800A (5 sek.) / 200A (kont). 8mm bolter / 2 flatstikk	
4110-5763	12V / 1P. / 100A (kont). 2x5mm og 2x8mm bolter Ingen kontaktbolter skal til minus. Jording er i festebraketten. Erstatter også releer med 3 kontaktbolter!	 <p> <span style="border: 1px solid black; padding: 2px;">Releterminal</span> <span style="border: 1px solid black; padding: 2px; margin-left: 100px;">Tenningslås</span>  <span style="border: 1px solid black; padding: 2px; margin-left: 10px;">Starter</span> <span style="border: 1px solid black; padding: 2px; margin-left: 100px;">Batteri +</span>  <span style="border: 1px solid black; padding: 2px; margin-left: 100px;">Batteri -</span>  <span style="margin-left: 100px;">43mm</span>  <span style="margin-left: 100px;">63mm</span> </p>

For å se alle modeller eller andre strl., se hele vårt sortiment på [www.importex24.no](http://www.importex24.no)

## RELEER

HOVEDSTRØMS RELEER		
Best.nr.	Tekn. data	
4100-622011	12V / 2P.	
4100-5533	12V / 2P. / 150A (kont). 2x5mm og 2x8mm bolter.	
4126-595588	24V / 2P. 500A (10 sek.) / 80A (kont). 2x5mm og 2x8mm bolter. Med startknapp.	
4100-5795	24V / 2P. 800A (5 sek.) / 200A (kont). 8mm bolter / 2 flatstikk.	
4100-5552	24V / 2P. 800A (5 sek.) / 200A (kont). 8mm bolter / 2 flatstikk.	

**VED KONTINUERLIG BRUK KAN ARBEIDSTEMPRATUR BLI MERE ENN 50 GRADER.  
BØR DA MONTERES PÅ ET VENTILERT STED FOR Å UNNGÅ OVER OPPHETING.**



**For å se alle modeller eller andre strl., se hele vårt sortiment på [www.importex24.no](http://www.importex24.no)**

## RELEER

START RELEER		
Best.nr.	Tekn. data	
240-22041	12V. Erstatter Yamaha: 6E5-81950-01.	
240-22042	12V. Erstatter Yamaha: 6E5-8195A01.	
4100-622014	12V / 2P. 2 x 1/4 - 28 bolter. Erstatter Yamaha: 688-91950-10.	
REVERSIBLE RELEER		
Best.nr.	Tekn. data	
240-22017	12V. For bruk på tilt / trim motorer, vinsjer, hydrauliske pumper m.m. 4 x 5/6" 24 gjenger. 2 x 6,3 flatstikk.	  Pluss styring opp / ned.
240-22034	12V. For bruk på tilt / trim motorer, vinsjer, hydrauliske pumper m.m. 4 x 6mm. bolter 3 x 3mm skruer.	



For å se alle modeller eller andre strl., se hele vårt sortiment på [www.importex24.no](http://www.importex24.no)

## KONTAKTER FOR ALTERNATORER

KONTAKT FOR ALTERNATOR		
Best.nr.	Beskrivelse	
3124-3852	Div. Toyota Leveres med korte ledninger	
1571-53370	Leveres med korte ledninger Div. denso	
3101-130000	Bosch NCB	



## STARTBOOSTERE

START BOOSTERE		
Best.nr.	Tekn. data	
1700-GB20	<p>GB20 Lithium booster er et fantastisk produkt fra Amerikanske Noco.</p> <p>Den er liten og kompakt så den enkelt får plass i hanskerommet.</p> <p>For bensinmotorer opp til 4L.</p> <p>Beregnet for bil, båt, MC, ATV, snøscooter etc.</p> <p>12V / 400A starteffekt / 4650 joules.</p> <p>Beskyttet mot feilkobling og overbelastning.</p> <p>Sprutsikker og støvtett (IP65).</p> <p>LED lys på 100 lumen for sikker tilkobling i mørket.</p> <p>USB utgang for lading av mobiltelefon ol.</p> <p>Gir opp til 20 boost på en lading.</p> <p>Mål: 168 x 81 x 43mm / ca.: 0,95 kg.</p>	
1700-GB40	<p>GB40 Lithium booster er et fantastisk produkt fra Amerikanske Noco.</p> <p>Den er liten og kompakt så den enkelt får plass i hanskerommet.</p> <p>For bensinmotorer opp til 6L / Diesel opp til 3L.</p> <p>Beregnet for bil, båt, anlegg og landbruk etc.</p> <p>12V / 1000A starteffekt / 7000 joules.</p> <p>Beskyttet mot feilkobling og overbelastning.</p> <p>Sprutsikker og støvtett (IP65).</p> <p>LED lys på 100 lumen for sikker tilkobling i mørket.</p> <p>USB utgang for lading av mobiltelefon ol.</p> <p>Gir opp til 20 boost på en lading.</p> <p>Mål: 168 x 81 x 43mm / ca.: 1,1 kg.</p>	
1700-GB70	<p>GB70 Lithium booster er et fantastisk produkt fra Amerikanske Noco.</p> <p>Den er liten og kompakt så den enkelt får plass i hanskerommet.</p> <p>For bensinmotorer opp til 8L / Diesel opp til 6L.</p> <p>Beregnet for bil, båt, anlegg og landbruk etc.</p> <p>12V / 2000A starteffekt / 12000 joules.</p> <p>Beskyttet mot feilkobling og overbelastning.</p> <p>Sprutsikker og støvtett (IP65).</p> <p>LED lys på 100 lumen for sikker tilkobling i mørket.</p> <p>USB utgang for lading av mobiltelefon ol.</p> <p>Gir opp til 40 boost på en lading.</p> <p>Mål: 210 x 99 x 64mm / ca.: 2,3 kg.</p>	

For å se alle modeller eller andre strl., se hele vårt sortiment på [www.importex24.no](http://www.importex24.no)

## STARTBOOSTERE

STARTBOOSTERE		
Best.nr.	Tekn. data	
1700-GB150	<p>GB150 Lithium booster er et fantastisk produkt fra Amerikanske Noco.</p> <p>Den er liten og kompakt så den enkelt får plass i hanskerommet.</p> <p>For bensin og dieselmotorer opp til 10L.</p> <p>Beregnet for bil, båt, anlegg og landbruk etc.</p> <p>12V / 4000A starteffekt / 22500 joules.</p> <p>Beskyttet mot feilkobling og overbelastning.</p> <p>Sprutsikker og støvtett (IP65).</p> <p>LED lys på 500 lumen for sikker tilkobling i mørket.</p> <p>Inkl. SOS og nødstroke.</p> <p>USB utgang for lading av mobiltelefon ol.</p> <p>Gir opp til 80 boost på en lading.</p> <p>Mål: 312 x 177 x 68mm / ca.: 2,3 kg.</p>	
1700-AT6059	<p>12V kontinuerlig 800A / maks 1200A.</p> <p>Sigarettenneruttak.</p> <p>26A batteri.</p>	
1700-LEPROF	<p>12V kontinuerlig 700A / maks 2600A.</p> <p>Sigarettenneruttak.</p> <p>16A batteri.</p>	
1700-LETRUCK	<p>12V kontinuerlig 1700A / maks 5000A.</p> <p>24V kontinuerlig 850A / maks 2500A.</p> <p>22A batteri.</p>	

For å se alle modeller eller andre strl., se hele vårt sortiment på [www.importex24.no](http://www.importex24.no)

## BATTERILADERE

BENTON BATTERILADERE		
Best.nr.	Tekn. data	
<b>1703-ECO4</b>	<p>5-trinns smartlader, helautomatisk switch mode uten mode knapp.                      Lader bly, AGM og GEL batterier.                      Ladespenning: 12V/4Amp.                      Vedlikeholdsområde: 12,8-14,7V                      For batterier fra 4 - 120Ah                      Kan lade dypt utladede batterier med spenning over 3 volt.                      Egnet for innendørs bruk fra -20 til +40°C                      IP52                      Ledningene er festet til klypene med skrue/øyesko for eventuell frakopling og direkte fastmontering til batteriet.                      Mål: 51x60x214mm.                      CE og TUV Godkjent.                      Bruksområde: Bil, båt, motorsykel, ATV snøscooter mm.</p>	
<b>1703-BX1PRO</b>	<p>5-trinns smartlader, helautomatisk switch mode med mode knapp.                      Lader bly, AGM og GEL batterier.                      Ladespenning: 12V/3,8Amp.                      Vedlikeholdsområde: 12,8-14,4V                      For batterier fra 1,2 - 120Ah                      Kan lade dypt utladede batterier med spenning over 3 volt.                      Egnet for utendørs bruk fra -20 til +50°C                      IP65                      Ledningene leveres med støpsel for valgfri tilkobling av klyper eller øyesko for direkte fastmontering til batteriet.                      Mål: 45x60x190mm.                      CE og TUV Godkjent.                      Bruksområde: Bil, båt, motorsykel, ATV snøscooter mm.</p>	
<b>1703-ICE5</b>	<p>8-trinns smartlader, helautomatisk switch mode med mode knapp.                      Lader bly-syre, AGM og GEL, VRLA og bly-kalsium batterier.                      Ladespenning: 12V/5Amp.                      Vedlikeholdsområde: 12,8-14,7V                      For batterier fra 1,2 - 120Ah                      Kan lade dypt utladede batterier med spenning over 2 volt.                      16 volt boost funksjon.                      Egnet for utendørs bruk fra -30 til +50°C                      IP65                      Ledningene leveres med støpsel for valgfri tilkobling av klyper eller øyesko for direkte fastmontering til batteriet.                      Mål: 51x60x214mm.                      CE og TUV Godkjent.                      Bruksområde: Bil, båt, motorsykel, ATV snøscooter mm.</p>	

For å se alle modeller eller andre strl., se hele vårt sortiment på [www.importex24.no](http://www.importex24.no)





## BATTERILADERE

BENTON BATTERILADERE		
Best.nr.	Tekn. data	
<b>1703-BX2</b>	<p>7-trinns smartlader, helautomatisk switch mode med mode knapp.                      Lader 12 og 24V bly, AGM og GEL batterier.                      Ladespenning: 12V/7Amp. og 24V/3,5Amp.                      Vedlikeholdsområde: 14,1V-14,4V og 28,2V-28,8V                      For 12V batterier fra 14 - 230Ah og 24V batterier fra 14-120Ah.                      Kan lade dypt utladede batterier med spenning over 4,5 volt.                      16 volt boost funksjon.                      Egnet for utendørs bruk fra -20 til +50°C                      IP65                      Kan også brukes som strømforsyning, maks kapasitet 13,6V/5Amp.                      Ledningene leveres med støpsel for valgfri tilkobling av klyper eller øyesko for direkte fastmontering til batteriet.                      Mål: 52x91x220mm.                      CE og TUV Godkjent.</p> <p>Bruksområde: Bil, båt, motorsykel, ATV snøscooter, lastebil, buss mm.</p>	
<b>1703-BX5</b>	<p>9-trinns smartlader, helautomatisk switch mode med mode knapp.                      Lader 12 og 24V bly-syre, AGM, GEL, MF, VRLA og bly-kalsium batterier.                      Ladespenning: 12V/25Amp. og 24V/12,5Amp.                      Vedlikeholdsområde: 12,8V-14,4V og 25,6V-28,8V                      For 12V bly-syre batterier fra 50 - 500Ah og 24V batterier fra 25-250Ah.                      For 12V bly-kalsium batterier fra 25-100Ah.                      Kan lade dypt utladede 12V batterier med spenning over 4,5 volt og 24V med spenning over 16V                      16 volt boost funksjon for 12v batterier og 32 volt for 24V batterier.                      Egnet for utendørs bruk fra -20 til +50°C                      IP44                      Kan også brukes som strømforsyning, maks kapasitet 13,6V/12,5Amp.                      Ledningene leveres med klyper og temperatur sensor.                      Mål: 70x135x260mm.                      CE og TUV Godkjent.</p> <p>Bruksområde: Bil, båt, lastebil, buss mm</p>	

For å se alle modeller eller andre strl., se hele vårt sortiment på [www.importex24.no](http://www.importex24.no)

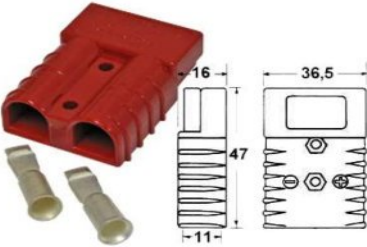
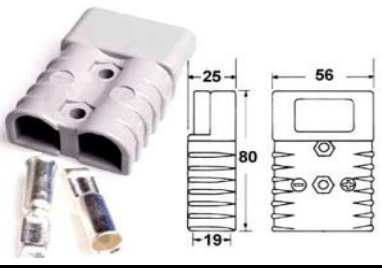
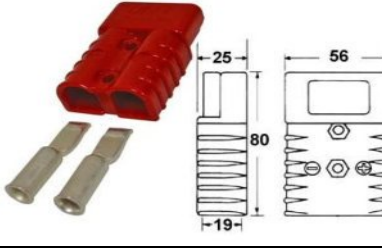







## LADEKONTAKTER

LADEKONTAKTER		
Best.nr.	Beskrivelse	
<b>1553-5970</b>	Lade og batteristikk for 36V. For 16kv. Kabel, maks 50A. Sølvbelagte kobberkontakter. Grå plast.	
<b>1553-5970R</b>	Lade og batteristikk for 36V. For 16kv. Kabel, maks 50A. Sølvbelagte kobberkontakter. Rød plast.	
<b>1553-5980</b>	Lade og batteristikk for 36V. For 35kv. Kabel, maks 175A. Sølvbelagte kobberkontakter. Grå plast.	
<b>1553-5980R</b>	Lade og batteristikk for 36V. For 35kv. Kabel, maks 175A. Sølvbelagte kobberkontakter. Rød plast.	
<b>1553-5990</b>	Lade og batteristikk for 36V. For 70kv. Kabel, maks 350A. Sølvbelagte kobberkontakter. Grå plast.	
<b>1553-5985</b>	Håndtak for 175 - 350A. Grå plast.	
<b>1553-5988</b>	Håndtak for 175 - 350A. Rød plast.	
<b>1553-59801</b> <b>1553-59901</b>	Lokk for 175A.  Lokk for 350A.	

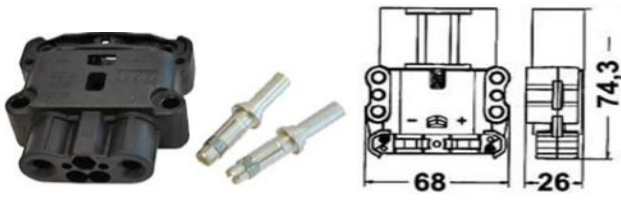
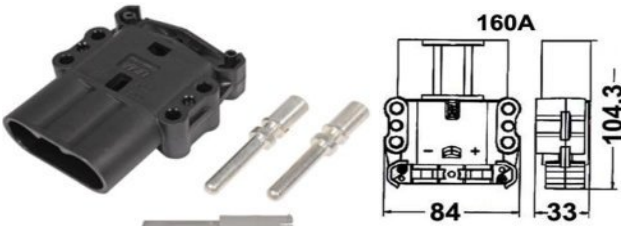
For å se alle modeller eller andre strl., se hele vårt sortiment på [www.importex24.no](http://www.importex24.no)

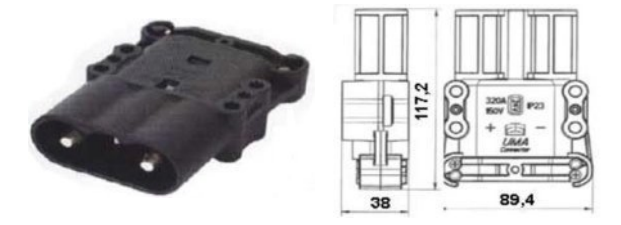
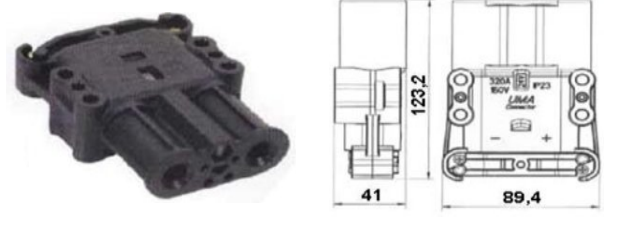

## LADEKONTAKTER

LADEKONTAKTER		
Best.nr.	Beskrivelse	
<b>1553-5971</b>	Han. For 16kv. kabel, maks 80A. Sølvbelagte kobberkontakter. Sort polyamid.	
<b>1553-5972</b>	Hun. For 16kv. kabel, maks 80A. Sølvbelagte kobberkontakter. Sort polyamid.	
<b>1553-5974</b>	Han. For 35kv. kabel, maks 160A. Sølvbelagte kobberkontakter. Sort polyamid.	
<b>1553-5975</b>	Hun. For 35kv. kabel, maks 160A. Sølvbelagte kobberkontakter. Sort polyamid.	
<b>1553-5977</b>	Han. For 50kv. kabel, maks 320A. Sølvbelagte kobberkontakter. Sort polyamid.	
<b>1553-5978</b>	Hun. For 50kv. kabel, maks 320A. Sølvbelagte kobberkontakter. Sort polyamid.	
Håndtak for Eurokontakter		
		
Best.nr.: 1553-5973 Håndtak for 80A. Sort polyamid / Inkl. skruer.	Best nr.: 1553-5976 Håndtak for 160A. Sort polyamid / Inkl. skruer.	Best nr.: 1553-5979 Håndtak for 320A. Sort polyamid / Inkl. skruer.

For å se alle modeller eller andre strl., se hele vårt sortiment på [www.importex24.no](http://www.importex24.no)

## SKILLEDIODER

### 2412-75

Skillediode maks 75A alternator.  
1 alternator, 2 batterier.  
Spenningsfall på 0,5V.

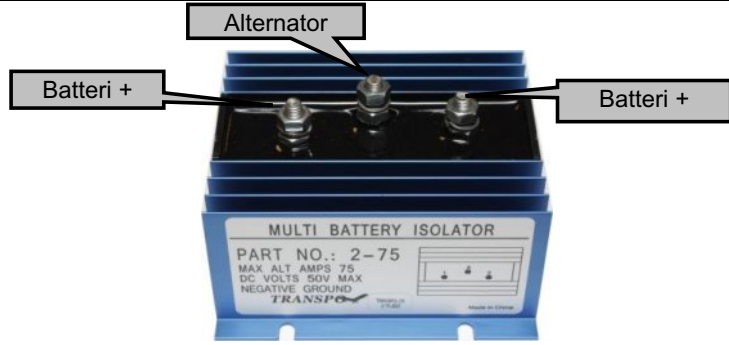

### 2412-100

Skillediode maks 100A alternator.  
1 alternator, 2 batterier.  
Spenningsfall på 0,5V.



### 2412-130

Skillediode maks 130A alternator.  
1 alternator, 2 batterier.  
Spenningsfall på 0,5V.



### 2412-240

Skillediode maks 240A alternator.  
1 alternator, 2 batterier.  
Spenningsfall på 0,5V.



### 2412-3130

Skillediode maks 130A alternator.  
1 alternator, 3 batterier.  
Spenningsfall på 0,5V.

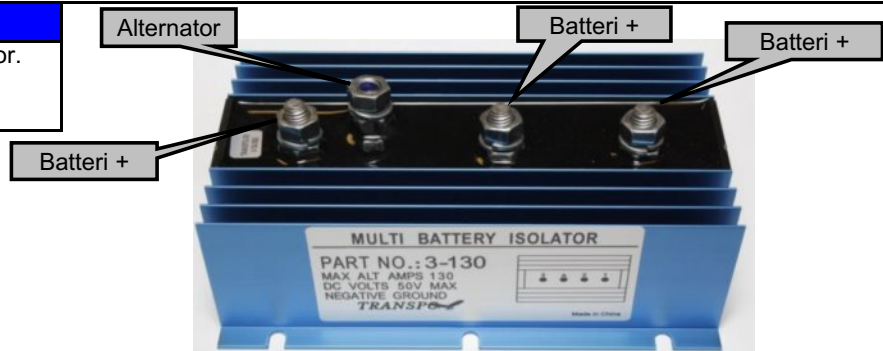

For å se alle modeller eller andre strl., se hele vårt sortiment på [www.importex24.no](http://www.importex24.no)

## OMFORMERE

<p><b>2412-10</b> 24 til 12V, 10A. For fast montering. Mål: 89 x 103 x 27mm.</p>	
<p><b>2412-13</b> 24 til 12V, 10A. Med sigarettenner uttak og 5V USB. Overvolt beskyttelse: 14,7 - 14,9V. Temperatur beskyttelse: 75 grader.</p>	
<p><b>2412-20</b> 24 til 12V, 20A. For fast montering. Mål: 116 x 170 x 35mm.</p>	
<p><b>2412-40</b> 24 til 12V, 40A. For fast montering. Mål: 73 x 180 x 73mm.</p>	
<p><b>JA-8661</b> 12 til 24V, 10A. Overvolt og kortslutnings beskyttelse. For fast montering. Mål: 115 x 140 x 70mm.</p>	
<p><b>1702-8690</b> 12 til 24V, 20A. For fast montering. Mål: 116 x 170 x 35mm.</p>	

For å se alle modeller eller andre strl., se hele vårt sortiment på [www.importex24.no](http://www.importex24.no)





## INVERTERE

INVERTERE		
Best.nr.	Tekn. data	
1702-8546	12V / 300W. Maks forbruk 35A. Kortvarig inngangseffekt 600W. Mål: 73 x 73 x 120mm.	
1702-8547	24V / 300W. Maks forbruk 15A. Kortvarig inngangseffekt 900W. Mål: 73 x 73 x 120mm.	
<b>Leveres med sigarettener støpsel.</b>		
1702-8548	12V / 600W. Maks forbruk 60A. Kortvarig inngangseffekt 1500W. Mål: 62 x 113 x 190mm.	
1702-8549	24V / 600W. Maks forbruk 30A. Kortvarig inngangseffekt 1500W. Mål: 62 x 113 x 190mm.	
1702-8550	12V / 1000W. Maks forbruk 100A. Kortvarig inngangseffekt 2000W. Mål: 80 x 198 x 300mm.	
1702-8551	24V / 1000W. Maks forbruk 50A. Kortvarig inngangseffekt 2000W. Mål: 80 x 198 x 300mm.	
1702-8552	12V / 1500W. Maks forbruk 150A. Kortvarig inngangseffekt 3000W. Mål: 80 x 198 x 360mm.	
1702-8553	24V / 1500W. Maks forbruk 75A. Kortvarig inngangseffekt 3000W. Mål: 80 x 198 x 360mm.	
1702-8556	12V / 3000W. Maks forbruk 300A. Kortvarig inngangseffekt 6000W. Mål: 148 x 138 x 400mm.	
1702-8557	24V / 3000W. Maks forbruk 150A. Kortvarig inngangseffekt 6000W. Mål: 148 x 138 x 400mm.	

For å se alle modeller eller andre strl., se hele vårt sortiment på [www.importex24.no](http://www.importex24.no)



## INVERTERE

INNVERTERE - REN SINUS		
Best. Nr.	Tekn. Data	
<b>1702-85600</b>	12V / 350W. Kan brukes på veldig sensitivt utstyr. Også for kjøretøy med Euro 6. Mål: 68 x 150 x 187mm.	
<b>1702-85610</b>	24V / 350W. Kan brukes på veldig sensitivt utstyr. Også for kjøretøy med Euro 6. Mål: 68 x 150 x 187mm.	
<b>1702-85620</b>	12V / 700W. Ny generasjon høyeffektivitet (91%). Inngangsspenning: 10,5 - 16,5V. Mål: 83 x 200 x 330mm.	
<b>1702-85630</b>	24V / 700W. Ny generasjon høyeffektivitet (93%). Inngangsspenning: 21 - 33V. Mål: 83 x 200 x 330mm.	
<b>1702-85640</b>	12V / 1000W. Inngangsspenning: 10,5 - 16,5V. Kan brukes på veldig sensitivt utstyr. Også for kjøretøy med Euro 6. Mål: 83 x 200 x 372mm.	
<b>1702-85650</b>	24V / 1000W. Inngangsspenning: 21 - 33V. Kan brukes på veldig sensitivt utstyr. Også for kjøretøy med Euro 6. Mål: 83 x 200 x 372mm.	
<b>1702-85660</b>	12V / 1500W. Inngangsspenning: 10,5 - 16,5V. Kan brukes på veldig sensitivt utstyr. Også for kjøretøy med Euro 6. Mål: 83 x 248 x 421mm.	
<b>1702-85670</b>	24V / 1500W. Inngangsspenning: 21 - 33V. Kan brukes på veldig sensitivt utstyr. Også for kjøretøy med Euro 6. Mål: 83 x 248 x 421mm.	
<b>1702-85720</b>	12V / 3500W. Inngangsspenning: 10,5 - 16,5V. Kan brukes på veldig sensitivt utstyr. Også for kjøretøy med Euro 6. Mål: 128 x 283 x 496mm.	
<b>1702-85730</b>	24V / 3500W. Inngangsspenning: 21 - 33V. Kan brukes på veldig sensitivt utstyr. Også for kjøretøy med Euro 6. Mål: 128 x 283 x 496mm.	

For å se alle modeller eller andre strl., se hele vårt sortiment på [www.importex24.no](http://www.importex24.no)



## STØPSLER /- KONTAKTER

STØPSLER /- KONTAKTER		
Best.nr.	Beskrivelse	
<b>113300</b>	12-24V. 2 polet, universal.	
<b>1800-0313</b>	12-24V. Maks 20A. For innfelling i 29mm hull. Utv. Dia. På krave er 37mm. Flatstikk tilkobling. -20° til +85°	
<b>1553-6811</b>	12-24V For innfelling i 18mm hull. 2 flatstikk tilkoblinger.	
<b>1800-0314</b>	12-24V. Maks 20A. For innfelling i 27mm hull. Utv. Dia. På krave er 36mm. Flatstikk tilkobling.	
<b>1800-0315</b>	12-24V For overflate montering. Flatstikk tilkobling.	
<b>1800-031515</b>	12V. Maks 16A. For overflate montering.	
<b>1800-0320</b>	12-24V. For innfelling eller flat montering. 1 x USB, maks effekt 2,1A/5V.	
<b>1800-031919</b>	12-24V. For innfelling i 30mm hull. Utv. Dia. På krave er 36mm. Flatstikk tilkobling. 2 x USB, maks lade effekt 5A. IP65.	

For å se alle modeller eller andre strl., se hele vårt sortiment på [www.importex24.no](http://www.importex24.no)

## STØPSLER /- KONTAKTER

STØPSLER /- KONTAKTER		
Best.nr.	Beskrivelse	
<b>1800-0319</b>	12-24V. For innfelling i 28mm hull. Utv. Dia. På krave er 37mm. Flatstikk tilkobling. 2 x USB, maks effekt 2,1A/5V. Ved begge i bruk, maks 1A pr. port.	
<b>1800-0317</b>	12-24V. 2 x USB, maks effekt 2,4A/5V.	
<b>1800-0327</b>	12-24V. Maks 10A. 1 til 2 + 2 x USB. 90° vendbar kontakt. USB uttak maks 2A.	
TILHENGERSTØPSLER /- KONTAKTER		
Best.nr.	Beskrivelse	
<b>1802-9450</b>	Tilkobling med flatstikk. Leveres med gummihette.	
<b>1802-9460</b>	3 polet i plast. For innfelling i 29mm hull. Hullavstand 47mm. 3 hunn kontakter.	
<b>1802-9440</b>	3 polet i plast. Skrutilkobling. 2 hann / 1 hunn kontakt.	
<b>1802-9430</b>	3 polet i plast. Skrutilkobling. 2 hann / 1 hann kontakt. Utv. dia. 64mm.	

For å se alle modeller eller andre strl., se hele vårt sortiment på [www.importex24.no](http://www.importex24.no)

## STØPSLER /- KONTAKTER

TILHENGERSTØPSLER /- KONTAKTER		
Best.nr.	Beskrivelse	
<b>1553-519790</b>	7 polet i plast 12V DIN ISO 1724 Tilhører best.nr <b>10000</b>	
<b>1553-401790</b>	7 polet i plast.                      12V DIN ISO 1724.                      Tilhører v.nr. <b>1553-519790.</b>	
<b>1553-516790</b>	7 polet i aluminium 12V DIN ISO 1724 Tilhører best.nr <b>1553-431790</b>	
<b>1553-431790</b>	7 polet i aluminium 12V DIN ISO 1724 Tilhører best.nr <b>1553-516790</b> Pakning best.nr <b>90004</b>	
<b>1553-585770</b>	7 polet i plast 24V ISO 7638 Tilhører best.nr <b>1553-595770</b>	
<b>1553-595770</b>	7 polet i plast 24V ISO 7638 Tilhører best.nr <b>1553-585770</b>	
<b>1553-6511</b>	7 polet i plast 24V ISO 7638 ADR-Godkjent.	

**Kabel til 7 polet kontakt / støpsel : 02314955**

For å se alle modeller eller andre strl., se hele vårt sortiment på [www.importex24.no](http://www.importex24.no)

## STØPSLER /- KONTAKTER

TILHENGERSTØPSLER /- KONTAKTER		
Best.nr.	Beskrivelse	
<b>1553-5113-BLIST</b>	13 polet i plast ISO 11446 Tilhører best.nr. <b>1553-4213-BLIST</b>	
<b>1553-4213-BLIST</b>	13 polet i plast ISO 11446 Tilhører best.nr. <b>1553-5113-BLIST</b>	

**Kabel til 13 polet kontakt / støpsel : 02314999**

<b>1553-5843</b>	15 polet i plast 24V ISO 12098 Tilhører best.nr <b>1553-5946</b>	
<b>1553-5946</b>	15 polet i plast 24V ISO 12098 Tilhører best.nr <b>1553-5843</b>	
<b>1553-6551</b>	15 polet i plast 24V ISO 12098 ADR-Godkjent.	

**Kabel til 15 polet kontakt / støpsel : 02315010**

For å se alle modeller eller andre strl., se hele vårt sortiment på [www.importex24.no](http://www.importex24.no)

## STØPSLER /- KONTAKTER

ADAPTERE		
Best.nr.	Beskrivelse	
<b>1553-5600-BLIST</b>	Overgang fra 7 polet kontakt på henger til 13 polet kontakt på bil. Plast.	
<b>1553-5549-BLIST</b>	Overgang fra 13 polet kontakt på henger til 7 polet kontakt på bil. Plast.	
NATO KONTAKTER		
BEST.NR	BESKRIVELSE	
<b>1802-9410</b>	2-pin for 50Kv kabel.	
<b>1802-9420</b> <b>1802-9421</b>	2-pin for 35Kv kabel. 2-pin for 50Kv kabel.	
<b>1802-9425</b>	2-pin for 35Kv kabel.	

For å se alle modeller eller andre strl., se hele vårt sortiment på [www.importex24.no](http://www.importex24.no)



## STØPSLER /- KONTAKTER

SPIRALKABLER		
Best.nr.	Beskrivelse	
<b>1561-550870</b>	7 polet spiralkabel. 7x1,5kv. Arbeidslengde 1,5m.	
<b>1561-521100</b>	15 polet spiralkabel i plast. 12x1,5kv + 3x2,5kv. Arbeidslengde 3,5m.	
<b>1561-558400</b>	7 polet EBS spiralkabel. 5x1,5kv + 2x4kv. Arbeidslengde 4m.	
<b>1561-559000</b>	15 polet spiralkabel. 12x1,5kv + 3x2,5kv. Arbeidslengde 4m.	
<b>1561-665577</b>	15polet + 7 polet 24N + 24S. Arbeidslengde 3,5m.	

For å se alle modeller eller andre strl., se hele vårt sortiment på [www.importex24.no](http://www.importex24.no)

## VINSJER

VINSJER		
Best.nr.	Tekn. data	
<b>9201-10032</b>	<p>Trekk kraft: 454kg.            Gir utveksling: 4,2 : 1            10m. X <math>\varnothing</math>4,76mm stålwire.            Mål 183 x 156 x 122mm.            Vekt: 3,2kg.            CE</p>	
<b>9201-10033</b>	<p>Trekk kraft: 454kg.            Gir utveksling: 4,2 : 1            10m. X 40x1,2mm stropp.            Mål 183 x 156 x 122mm.            Vekt: 3,2kg.            CE</p>	
<b>9201-10000</b>	<p>12V / 1,4KW.            Trekk kraft: 907kg.            Gir utveksling: 153 : 1.            Automatisk brems, frihjul.            15m. X <math>\varnothing</math>4mm stålwire.            Leveres med fjernkontroll m/ kabel.            Mål: 285 x 113 x 107mm            Avstand festehull: 48 x 76mm.            Vekt: 6,5kg.            CE, IP65</p>	

For å se alle modeller eller andre strl., se hele vårt sortiment på [www.importex24.no](http://www.importex24.no)

## VINSJER

VINSJER		
Best.nr.	Tekn. data	
<b>9201-10005</b>	<p>12V / 2,3KW.                      Trekk kraft: 1589kg.                      Gir utveksling: 136 : 1.                      Automatisk brems, frihjul.                      12,8m. X ø5,56mm stålwire.                      Leveres med festebrakett, rele, kabler,                      wireguide, og fjenkontroll m/ kabel.                      Mål: 363 x 117 x 120mm                      Avstand festehull: 76,2 x 124mm.                      Vekt: 11,3kg.                      CE, IP67</p>	 <p>The image shows the Vinsjer RP3500 winch, a black cylindrical unit with a silver wire spool. It is accompanied by various accessories including a metal mounting bracket, a remote control with a red trigger, a black control box, a black cable, a yellow and blue coiled cable, and a metal hook with an orange strap.</p>
<b>9201-10007</b>	<p>12V / 2,8KW.                      Trekk kraft: 2268kg.                      Gir utveksling: 165 : 1.                      Automatisk brems, frihjul.                      15m. X ø6,3mm stålwire.                      Leveres med rele, wireguide                      og fjenkontroll m/ kabel.                      Mål: 397 x 117 x 120mm                      Avstand festehull: 76 x 168mm.                      Vekt: 13,6kg.                      CE, IP67</p>	 <p>The image shows the Vinsjer ROCK winch, a grey cylindrical unit with a silver wire spool. It is shown with a metal hook and an orange strap.</p>
<b>9201-100192</b>	<p>12V / 3,6KW.                      Trekk kraft: 5445kg.                      Gir utveksling: 210 : 1.                      Automatisk brems, frihjul.                      30,5m. X ø9,5mm stålwire.                      Leveres med rele, wireguide                      og fjenkontroll m/ kabel.                      Mål: 548 x 167 x 217mm                      Avstand festehull: 114,3 x 254mm.                      Vekt: 37,2kg.                      CE, IP67</p>	 <p>The image shows the Vinsjer RES18000 winch, a large black cylindrical unit with a silver wire spool. It is shown with a metal hook and an orange strap.</p>

For å se alle modeller eller andre strl., se hele vårt sortiment på [www.importex24.no](http://www.importex24.no)

## RYGGEKAMERAER

RYGGEKAMERAER		
Best.nr.	Tekn. data	
<b>1705-00009</b>	<p>Komplett sett med skjerm, kamera, kabel og fj.kontroll. 7" skjerm kan vise ett bilde om gangen. Ett kamera uten lukker, med oppvarming og mikrofon. IP68.</p> <p>Med 18IR-LED som gir inntil 15m. nattsyn. Leveres med 20m kabel og fjernkontroll. Arbeidstemperatur: -20 til + 70 grader. 12-32 Volt.</p>	
<b>1705-00010</b>	<p>Komplett sett med skjerm, kamera, kabel og fj.kontroll. 7" skjerm kan vise inntil fire kameraer samtidig. Ett kamera uten lukker, med oppvarming og mikrofon. IP69K.</p> <p>Med 12IR-LED. Leveres med 15m kabel og fjernkontroll. Kan ettermonteres ytterligere 3 kameraer uten lukking (1705-00029). 12-24 Volt.</p>	<p style="text-align: center;"><b>S-VISION</b></p> 
<b>1705-00011</b>	<p>Komplett sett med skjerm, kamera, kabel og fj.kontroll. 7" skjerm kan vise inntil fire kameraer samtidig. Ett kamera med lukker, oppvarming og mikrofon. IP69K.</p> <p>Med 12IR-LED som gir inntil 10m. nattsyn. Leveres med 20m kabel og fjernkontroll. Kan ettermonteres ytterligere 3 kameraer uten lukking (1705-00029). 12-24 Volt.</p>	<p style="text-align: center;"><b>S-VISION</b></p> 
<b>1705-00016</b>	<p>Komplett sett med skjerm, kamera, kabel og fj.kontroll. 7" skjerm kan vise ett bilde om gangen. Ett kamera uten lukker, med oppvarming og mikrofon. IP69K.</p> <p>Med 18IR-LED. Trådløs overføring av bilde. Leveres med fjernkontroll. Kan ettermonteres ytterligere 3 kameraer uten lukking (1705-00022). 12-32 Volt.</p>	<p style="text-align: center;"><b>S-VISION</b></p> 
<b>1705-00040</b>	<p>7" berørings-skjerm kan vise ett bilde om gangen. Kan tilkobles ett kamera med lukking (1705-00030) og 3 kamera meduten lukking (1705-00029). Leveres med fjernkontroll.</p>	

For å se alle modeller eller andre strl., se hele vårt sortiment på [www.importex24.no](http://www.importex24.no)

## RYGGEKAMERAER

RYGGEKAMERAER		
Best.nr.	Tekn. data	
<b>1705-00034-HD</b>	<p>7" berøringsskjerm kan vise inntil 4 bilder samtidig.                      Støtter inntill 1920 x 1080 PX.                      Kan tilkobles ett kamera med lukking (1705-00030-HD) og 3 kamera uten lukking (1705-00029-HD).                      Har innebygd høyttaler.                      Avansert modell med mange visnings alternativer.                      Leveres med fjernkontroll.                      10-32 Volt.</p>	
<b>1705-00029</b>	<p>Kamera med 120 graders linse uten lukkerdeksel, med oppvarming og mikrofon.                      IP69K.                      Med 12IR-LED.                      For kabel med 4-pins kontakt.                      Kan brukes sammen med 1705-0009, 1705-00010 og 1705-00011.</p>	<p><b>S-VISION</b></p> 
<b>1705-00030</b>	<p>Kamera med 180 graders linse, automatisk lukkerdeksel, oppvarming og mikrofon.                      IP69K.                      Med 4 IR-LED som gir inntil 10m. nattsyn.                      For kabel med 5-pins kontakt.                      Kan brukes sammen med 1705-00011.</p>	
<b>1705-00029-HD</b>	<p>HD kamers med 130 graders linse, uten lukkerdeksel, med oppvarming og mikrofon.                      IP69K, ISO 16750-3.                      Med 4 IR-LED som gir inntil 10m. nattsyn.                      For kabel med 4-pins kontakt.                      Kan brukes sammen med 1705-00034-HD.</p>	
<b>1705-00030-HD</b>	<p>HD kamers med 130 graders linse, med lukkerdeksel, med oppvarming og mikrofon.                      IP69K, ISO 16750-3.                      Med 4 IR-LED som gir inntil 10m. nattsyn.                      For kabel med 5-pins kontakt.                      Kan brukes sammen med 1705-00034-HD.</p>	

For å se alle modeller eller andre strl., se hele vårt sortiment på [www.importex24.no](http://www.importex24.no)



## RYGGEKAMERAER

RYGGEKAMERAER		
Best.nr.	Tekn. data	
<b>1705-00022</b>	<p>Kamera med 120 graders linse, uten lukkerdeksel, med oppvarming og mikrofon. IP69K. Med 12IR-LED. Trådløst Kan brukes sammen med 1705-00016.</p>	
SKILTBRACKET M/ KAMERA		
Best.nr.	Tekn. data	
<b>1705-00024</b>	<p>Kamera med 180 graders linse. IP69K. Med 4 IR-LED som gir inntil 5m. nattsyn. For kabel med 4-pins kontakt. Kan brukes sammen med 1705-0009, 1705-00010 og 1705-00011. Mål: 140 x 503mm.</p>	
BREMSSELYS M/ KAMERA		
Best.nr.	Tekn. data	
<b>1705-00080</b>	<p>For MB Vito 2016- med enkel bakhjør. Kamera med 170 graders linse. Leveres med 4m. kabel med 4-pins kontakt. Brukstemperatur: -30 til + 70 grader. IP69K, ISO9001, FCC-CE/E, TS16984, ROHS. Mål: 488,6 x 35,3mm.</p>	
<b>1705-00071</b>	<p>For Ford Transit 2015-. Kamera med 120 graders linse. Leveres med 388mm. kabel med 4-pins kontakt. Brukstemperatur: -30 til + 70 grader. IP69K, ISO9001, FCC-CE/E, TS16984, ROHS. Mål: 386,9 x 42,7mm.</p>	
<b>1705-00092</b>	<p>For Ford Transit Connect 2014-2017. Kamera med 170 graders linse. For kabel med 4-pins kontakt. Brukstemperatur: -30 til + 70 grader. IP69K, ISO9001, FCC-CE/E, TS16984, ROHS.</p>	
<b>1705-00077</b>	<p>For Peugeot Expert, Citroen Space Tourer og Toyota Proace 2016- med doble bakhjører. Kamera med 170 graders linse. Leveres med 2700mm. kabel med 4-pins kontakt. Brukstemperatur: -30 til + 70 grader. IP69K, ISO9001, FCC-CE/E, TS16984, ROHS. Mål: 262,5 x 31,7mm.</p>	

**For å se alle modeller eller andre strl., se hele vårt sortiment på [www.importex24.no](http://www.importex24.no)**

## RYGGEKAMERAER

BREMSSELYS M/ KAMERA		
Best.nr.	Tekn. data	
1705-00081	For VW Crafter 2017-. Kamera med 120 graders linse. Leveres med kabel med 4-pins kontakt. Brukstemperatur: -30 til + 70 grader. IP69K, ISO9001, FCC-CE/E, TS16984, E-merket, ROHS. Mål: 532,8 x 187,7mm.	
1705-00084	For VW Transporter T6 med hevedør 2016-. Kamera med 170 graders linse. Leveres med kabel med 4-pins kontakt. Brukstemperatur: -30 til + 70 grader. IP69K, ISO9001, FCC-CE/E, TS16984, ROHS. Mål: 337,2 x 36,8mm.	
KABEL FOR RYGGEKAMERAER		
Best.nr.	Tekn. data	
1705-00050	10m kabel for kamera uten lukking. 4-pins kontakter.	 
1705-00051	15m kabel for kamera uten lukking. 4-pins kontakter.	
1705-00052	20m kabel for kamera uten lukking. 4-pins kontakter.	
1705-00061	15m kabel for kamera med lukking. 5-pins kontakter.	
1705-00062	20m kabel for kamera med lukking. 5-pins kontakter.	
KAMERAKABEL		
Best.nr.	Tekn. data	
1705-00063	Spiralkabel med 5-pins kontakter. For bruk mellom kjøretøy og henger.	
FESTEFOT		
Best.nr.	Tekn. data	
1705-00038	Festefot for fast montering. Hodet kan dreies 360 grader.	
FESTEFOT		
Best.nr.	Tekn. data	
1705-00101	Festefot med sugekopp.	

For å se alle modeller eller andre strl., se hele vårt sortiment på [www.importex24.no](http://www.importex24.no)

**VI LAGERFØRER ETT AV NORGES BREDESTE SORTIMENT PÅ ALT AV LYS  
TIL KJØRETØY, MASKINER OG MARINE. SE [WWW.STARTAX.NO](http://WWW.STARTAX.NO) /  
[WWW.THELIGHTS.NO](http://WWW.THELIGHTS.NO) ELLER BE OM EGEN KATALOG.**

### **Ekstralys:**



### **Arbeidsllys:**



### **Hovedlys:**



### **Varsellys:**



### **Baklys:**



### **Markeringslys:**



### **Marinelys:**



For å se alle modeller eller andre strl., se hele vårt sortiment på [www.importex24.no](http://www.importex24.no)







## KOBLINGSSETT FOR EKSTRALYS

KOBLINGSSETT FOR EKSTRALYS		
Best.nr.	Beskrivelse	
<b>1605-WK005L</b>	<p><b>For 2 lamper med kabelsko.</b> Leveres med releholder og rele. 12V / 40A. Maks 160W Sikringsholder med 15A sikring. Vippebryter med blått LED lys.</p>	
<b>1605-WK007</b>	<p><b>For 2 lamper med kabelsko.</b> Leveres med 2 releholdere. 12V / 2 x 40A releer. Maks 300W Innfellbar bryter med lys.</p>	
<b>1605-WK022</b>	<p><b>For 2 lamper med kabelsko.</b> Leveres med 12V - 24V rele. For max 300W. Med fjernkontroll.</p>	
<b>1605-WK028</b>	<p><b>For 3 lamper med kabelsko.</b> Leveres med releholder. 12V / 40A rele. Max 300W. 30A sikring og bryter.</p>	
<b>1605-WK027</b>	<p><b>For 3 lamper med kabelsko.</b> Leveres med releholder. 12V / 60A rele. For max 750W. 50A sikring og bryter. Arb.temp.: -40 til +105 grader.</p>	
<b>1605-WK014</b>	<p><b>For 1 lampe med DT kontakt.</b> Leveres med releholder og rele. 12V / 40A. Sikringsholder med 15A sikring. 2,5m kabel med DT kontakt. Fast montering uten bryter. <b>For 24V bruk rele 20401103N.</b></p>	

For å se alle modeller eller andre strl., se hele vårt sortiment på [www.importex24.no](http://www.importex24.no)



## KOBLINGSSETT FOR EKSTRALYS

KOBLINGSSETT FOR EKSTRALYS		
Best.nr.	Beskrivelse	
<b>1605-WK018</b>	<p><b>For 1 lampe med DT kontakt.</b> Leveres med 12V rele. For max 300W. Arb.temp. -40 til +105 grader.</p>	
<b>1605-WK021</b>	<p><b>For 1 lampe med DTP kontakt.</b> Leveres med releholder. 12V / 40A rele. For max 320W. Arb.temp.: -40 til +105 grader.</p>	
<b>1605-WK015</b>	<p><b>For 1 lampe med 3pins DT kontakt.</b> Leveres med releholder. 12V / 40A rele. 2,5m kabel m/ 3pins DT kontakt og bryter. Sprutsikker sikringsboks med 15 A sikring.</p>	
<b>1605-WK013</b>	<p><b>For 2 lamper med DT kontakt.</b> Leveres med releholder og rele. 12V / 40A. Sikringsholder med 15A sikring. 2 x 2,5m kabler med DT kontakter. Fast montering uten bryter.</p>	
<b>1605-WK023</b>	<p><b>For 2 lamper med DT kontakt.</b> Leveres med releholder og bryter. 12V / 30A rele. For max 300W. Arb.temp.: -40 til +150 grader.</p>	
<b>1605-WK019</b>	<p><b>For 2 lamper med DT kontakt.</b> Leveres med releholder og bryter. 12V / 60A rele. Max 500W. Arb.temp.: -40 til +105 grader.</p>	

For å se alle modeller eller andre strl., se hele vårt sortiment på [www.importex24.no](http://www.importex24.no)



## KOBLINGSSETT FOR EKSTRALYS

KOBLINGSSETT FOR EKSTRALYS		
Best.nr.	Beskrivelse	
<b>1605-WK024</b>	<p><b>For 3 lamper med DT kontakt.</b> Leveres med releholder. 12V / 40A. Sikringsholder med 15A sikring. 3x 2,5m kabel med DT kontakter. Fast montering uten bryter.</p>	
<b>1605-WK002</b>	<p><b>For 1 lampe.</b> <b>For CAN BUS uten automatisk styring.</b> Leveres med 12V (2x200W) / 24V (2x400W). Vippebryter med blått LED lys.</p>	
<b>1605-WK004</b>	<p><b>For 2 lamper.</b> <b>For CAN BUS uten automatisk styring.</b> Leveres med 12V (2x100W) / 24V (2x200W). Vippebryter med blått LED lys.</p>	
<b>1605-WK011</b>	<p><b>For 2 lamper.</b> <b>For CAN BUS uten automatisk styring.</b> Leveres med 12V (2x150W) / 24V (2x300W). Vippebryter med blått LED lys.</p>	
<b>1605-WK031</b>	<p><b>For 1 lampe med DT kontakt.</b> <b>For CAN BUS.</b> Leveres med 12V (1x200W) / 24V (1x400W). Releer er vanntett med automatsikring. Rask, enkel og sikker montering. <b>(Sett 1)</b></p>	
<b>1605-WK032</b>	<p><b>For 2 lamper med DT kontakt.</b> <b>For CAN BUS.</b> Leveres med 12V (2x100W) / 24V (2x200W). Releer er vanntett med automatsikring. Rask, enkel og sikker montering. <b>(Sett 2)</b></p>	



For å se alle modeller eller andre strl., se hele vårt sortiment på [www.importex24.no](http://www.importex24.no)





## KOBLINGSSETT FOR EKSTRALYS

KOBLINGSSETT FOR EKSTRALYS		
Best.nr.	Beskrivelse	
<b>1605-WK033</b>	<p style="text-align: center;"><b>For 3 lamper med DT kontakt.</b> <b>For CAN BUS.</b></p> <p>Leveres med 12V (3x250W) / 24V (3x500W). Releet er vanntett med automatsikring. Rask, enkel og sikker montering. <b>(Sett 3)</b></p>	
<b>1605-WK034</b>	<p style="text-align: center;"><b>For 1 lampe med 3pins DT kontakt.</b> <b>For CAN BUS.</b></p> <p>Leveres med 12V (1x200W) / 24V (1x400W). Releet er vanntett med automatsikring. Rask, enkel og sikker montering. <b>(Sett 4)</b></p>	
<b>1605-WK035</b>	<p style="text-align: center;"><b>For 1 lampe med DTP kontakt.</b> <b>For CAN BUS.</b></p> <p>Leveres med 12V (1x300W) / 24V (1x600W). Releet er vanntett med automatsikring. Rask, enkel og sikker montering. <b>(Sett 5)</b></p>	
<b>1605-WK036</b>	<p style="text-align: center;"><b>For 2 lamper med DTP kontakt.</b> <b>For CAN BUS.</b></p> <p>Leveres med 12V (2x150W) / 24V (2x300W). Releet er vanntett med automatsikring. Rask, enkel og sikker montering. <b>(Sett 6)</b></p>	
<b>1605-WK050</b>	<p style="text-align: center;">Skjøtekabel for 2 pins DT-kontakt (1,35m.) <b>(Sett A)</b></p>	
<b>1605-WK051</b>	<p style="text-align: center;">Skjøtekabel for 2 pins DTP-kontakt (1,35m.) <b>(Sett B)</b></p>	

For å se alle modeller eller andre strl., se hele vårt sortiment på [www.importex24.no](http://www.importex24.no)

## KOBLINGSSETT FOR EKSTRALYS

KOBLINGSSETT FOR EKSTRALYS		
Best.nr.	Beskrivelse	
1605-WK052	Lysbryter med kabel (2m.) <b>(Sett C)</b>	
1605-WK008	<b>For CAN BUS med automatisk styring.</b> Max 12V (2x100W / 24V 2x200W). Ta kontakt for koblingsskjema til din bil.	
1605-WK009	Induktiv leser for CAN BUS signaler. Klemmes over CAN BUS høy / lav ledningene og leser signaler uten å måtte kappe ledningene.	

HOVEDLYSKONTAKTER		
Best.nr.	Beskrivelse	
1605-1501	For H1 / H3 pære	
1605-1504	For H4 pære Kabler ut på siden	
1605-1500	For H7 pære Kabler ut på siden	
PÆRESOKKEL M/STØYFILTER		
1605-1544	Støyfilter for H7 / CAN-BUS Med støpsler og 300mm kabel	







For å se alle modeller eller andre strl., se hele vårt sortiment på [www.importex24.no](http://www.importex24.no)

## DT-KONTAKTER

DT- KONTAKTER		
Best.nr.	Beskrivelse	
<b>1605-N8K047</b>	2-Pin (0,5 - 1,5mm <sup>2</sup> ) Løs Pin: Varenr.: 1605-N8K003	
<b>1605-N8K046</b>	2-Pin (0,5 - 1,5mm <sup>2</sup> ) Løs Pin: Varenr.: 1605-N8K002	
<b>1605-N8K045</b>	2-Pin (0,5 - 1,5mm <sup>2</sup> ) m / gummi-hette. Løs Pin: Varenr.: 1605-N8K003	
<b>1605-N8K050</b>	2-Pin (0,5 - 1,5mm <sup>2</sup> ) m / gummi-hette. Løs Pin: Varenr.: 1605-N8K002	
<b>1605-N8K052</b>	3-Pin (0,5 - 1,5mm <sup>2</sup> ) m / gummi-hette. Løs Pin: Varenr.: 1605-N8K003	
<b>1605-N8K051</b>	3-Pin (0,5 - 1,5mm <sup>2</sup> ) m / gummi-hette. Løs Pin: Varenr.: 1605-N8K002	
<b>1605-N8K049</b>	4-Pin (0,5 - 1,5mm <sup>2</sup> ) Løs Pin: Varenr.: 1605-N8K003	

For å se alle modeller eller andre strl., se hele vårt sortiment på [www.importex24.no](http://www.importex24.no)





## DT-KONTAKTER

DT- KONTAKTER		
Best.nr.	Beskrivelse	
<b>1605-N8K048</b>	4-Pin (0,5 - 1,5mm <sup>2</sup> ) Løs Pin: Varenr.: 1605-N8K002	
<b>1605-N8K056</b>	6-Pin (0,5 - 1,5mm <sup>2</sup> ) m / gummi-hette. Løs Pin: Varenr.: 1605-N8K003	
<b>1605-N8K055</b>	6-Pin (0,5 - 1,5mm <sup>2</sup> ) m / gummi-hette. Løs Pin: Varenr.: 1605-N8K002	
<b>1605-N8K058</b>	8-Pin (0,5 - 1,5mm <sup>2</sup> ) m / gummi-hette. Løs Pin: Varenr.: 1605-N8K003	
<b>1605-N8K057</b>	8-Pin (0,5 - 1,5mm <sup>2</sup> ) m / gummi-hette. Løs Pin: Varenr.: 1605-N8K002	
<b>1605-N8K060</b>	12-Pin (0,5 - 1,5mm <sup>2</sup> ) m / gummi-hette. Løs Pin: Varenr.: 1605-N8K003	
<b>1605-N8K059</b>	12-Pin (0,5 - 1,5mm <sup>2</sup> ) m / gummi-hette. Løs Pin: Varenr.: 1605-N8K002	

For å se alle modeller eller andre strl., se hele vårt sortiment på [www.importex24.no](http://www.importex24.no)









## DT-KONTAKTER

DT- KONTAKTR MED KABEL		
Best.nr.	Beskrivelse	
<b>1605-N8K200</b>	2-Pin med 2m kabel (1,5mm <sup>2</sup> ). Løs Pin: Varenr.: 1605-N8K002.	
<b>1605-N8K500</b>	2-Pin med 5m kabel (1,5mm <sup>2</sup> ). Løs Pin: Varenr.: 1605-N8K002.	
<b>1605-N8K501</b>	2-Pin overgang fra 1 til 2 kabler. Løs Pin: Varenr.: 1605-N8K002.	
<b>1605-N8K502</b>	2-Pin overgang fra 1 til 2 kabler. m / beskyttelsesstrømpe. Løs Pin: Varenr.: 1605-N8K002.	







For å se alle modeller eller andre strl., se hele vårt sortiment på [www.importex24.no](http://www.importex24.no)

## DT-KONTAKTER

TILBEHØR TIL DT- KONTAKTER		
Best.nr.	Beskrivelse	
<b>1605-N8K120</b>	Støvhette for 2-Pin DT kontakt. For bruk når kontaktene ikke er sammenkoblet.	
<b>1605-N8K002</b> <b>1605-N8K004</b> <b>1605-N8K020</b>	Hun 0,5 - 1,5mm <sup>2</sup> . Hun 1,0 - 2,0mm <sup>2</sup> . Hun 2,0 - 3,0mm <sup>2</sup> . Løse kontakt pin for DT kontakter.	
<b>1605-N8K003</b> <b>1605-N8K005</b> <b>1605-N8K021</b>	Han 0,5 - 1,5mm <sup>2</sup> . Han 1,0 - 2,0mm <sup>2</sup> . Han 2,0 - 3,0mm <sup>2</sup> . Løse kontakt pin for DT kontakter.	
ASS. DT- KONTAKT SETT		
Best.nr.	Beskrivelse	
<b>1605-N8K141</b>	Assortement. 260 deler levert i plastikk koffert.	
DIV. VERKTØY		
<b>1605-N8K131</b>	Verktøy for å ta ut DT Pin.	
<b>1605-N8K132</b>	Verktøy for å ta ut DT Pin. Størrelse 16. Passer for: DT, HD10, HD30, HDP20,DRC, AEC, JIFFY.	
<b>1726-40030</b>	Verktøy for klemming av DT Pin. (0,75 - 1,5mm <sup>2</sup> )	
<b>1726-40031</b>	Verktøy for klemming av DT Pin. (0,3 - 0,5mm <sup>2</sup> )	







For å se alle modeller eller andre strl., se hele vårt sortiment på [www.importex24.no](http://www.importex24.no)

## MONTERINGSBRAKETTER

MONTERINGSBRAKETTER		
Best.nr.	Beskrivelse	
<b>1605-NS71</b>	Monteringsbrakett: Sort.	
<b>1605-NS72</b>	Monteringsbrakett: Aluminium.	
<b>1605-3010</b>	For montering bak reg.nr. Sort.	
<b>1605-3011</b>	For montering bak EU reg.nr. Sort:	
<b>1605-3021</b>	For montering bak EU reg.nr. Sort. HD modell, tykkelse 3mm.	
<b>1605-3022</b>	For montering bak EU reg.nr. Rustfritt stål. HD modell, tykkelse 3mm.	

**For å se alle modeller eller andre strl., se hele vårt sortiment på [www.importex24.no](http://www.importex24.no)**

## MONTERINGSBRAKETTER

MONTERINGSBRAKETTER		
Best.nr.	Beskrivelse	
<b>1605-3023</b>	For 3 lamper. Montering bak EU reg.nr. Sort. HD modell, tykkelse 3mm.	
<b>1605-3024</b>	For montering bak EU reg.nr. Sort. Typoon. HD modell, tykkelse 3mm.	
<b>1605-3025</b>	For montering bak EU reg.nr. Sort. X-Vision Race R 2/4. HD modell. HD modell, tykkelse 3mm.	
<b>1605-3026</b>	For montering bak EU reg.nr. Rustfritt stål. HD modell, tykkelse 3mm.	
<b>1605-3028</b>	For 3 lamper. For montering bak EU reg.nr. Rustfritt stål. HD modell, tykkelse 3mm.	
<b>1605-3030</b>	For EU reg. nr. Rørdiameter 30mm. Sort.	

**For å se alle modeller eller andre strl., se hele vårt sortiment på [www.importex24.no](http://www.importex24.no)**

## MONTERINGSBRAKETTER

MONTERINGSBRAKETTER		
Best.nr.	Beskrivelse	
<b>1605-NS50</b>	Ø43mm, rustfritt stål.	
<b>1605-NS54</b>	Ø48mm, rustfritt stål.	
<b>1605-NS51</b>	Ø60mm, rustfritt stål.	
<b>1605-NS53</b>	Ø63mm, rustfritt stål.	
<b>1605-NS57</b>	Ø70mm, rustfritt stål.	
<b>1605-NS52</b>	Ø76mm, rustfritt stål.	
<b>1603-100000</b>	Monteringsmagnet. Utvendig dia. 77mm.	

For å se alle modeller eller andre strl., se hele vårt sortiment på [www.importex24.no](http://www.importex24.no)



## STØTTESTAG

STØTTESTAG		
Best.nr	Beskrivelse	
<b>1605-NS31</b>	Flat, 200mm, 2 stk., krom.	SEEKER 
<b>1605-NS32</b>	Flat 200mm, 2 stk., sort.	SEEKER 
<b>1605-NS33</b>	Rund, 200mm, 2 stk., sort.	SEEKER 
<b>1605-NS34</b>	Rund, 200mm, 2stk., krom.	SEEKER 
<b>1605-NS38</b>	Solid PRO modell i rustfritt stål.	
<b>1605-NS38BLACK</b>	Solid PRO modell i rustfritt stål, sort.	
<b>29-2806-RST</b>	Flat 200mm, 2 stk., rustfritt stål, krom.	
<b>29-2807-RST</b>	Flat 200mm, 2 stk., rustfritt stål, sort.	

For å se alle modeller eller andre strl., se hele vårt sortiment på [www.importex24.no](http://www.importex24.no)

## LANTERNER

LANTERNER LED		
Best.nr.	Beskrivelse	
1800-087LED	12V Hvitt lys Belysningsvinkel 360° Høyde 230mm Høyde kan tilpasses ved å kappe rør.	
1800-088LED	12V Hvitt lys Belysningsvinkel 360° Høyde 610mm Høyde kan tilpasses ved å kappe rør.	
1800-089LED	12V Hvitt lys Belysningsvinkel 360° Høyde 610mm Avtagbar med støpsel.	

For å se alle modeller eller andre strl., se hele vårt sortiment på [www.importex24.no](http://www.importex24.no)

## LANTERNER

LANTERNER LED		
Best.nr.	Beskrivelse	
1800-090LED	12V Rødt og grønt lys.	
1800-091LED	9-33V, 2W Hvitt lys Belysningsvinkel: 225° Leveres med 2m kabel. IP67 Dimensjon: 88x78x50mm	
1800-092LED	9-33V, 2W Hvitt lys. Belysningsvinkel: 135° Leveres med 2m kabel. IP67 Dimensjon: 88x78x50mm	

For å se alle modeller eller andre strl., se hele vårt sortiment på [www.importex24.no](http://www.importex24.no)

## LANTERNER

LANTERNER LED		
Best.nr.	Beskrivelse	
<b>1800-093LED</b>	9-33V, 2W Grønt lys. Belysningsvinkel: 112,5° Leveres med 2m kabel. IP67 Dimensjon: 88x78x50mm	
<b>1800-094LED</b>	9-33V, 2W Rødt lys. Belysningsvinkel: 112,5° Leveres med 2m kabel. IP67 Dimensjon: 88x78x50mm	
<b>1800-098LED</b>	9-33V, 2W Grønt og rødt lys. Belysningsvinkel: 112,5° Leveres med 2m kabel. IP67 Dimensjon: 88x78x43mm	

For å se alle modeller eller andre strl., se hele vårt sortiment på [www.importex24.no](http://www.importex24.no)

## LED LOMMELYKTER / HODELYKTER / ARB. LAMPER

LED LOMMELYKTER / HODELYKTER		
Best.nr.	Tekn. data	
<b>1700-AT780</b>	<p>Hodelyktsett                      Stor: 2200mAh., 18650 batteri. 27 x 107mm.                      Liten: 700mAh., 16340 batteri. 27 x 73mm                      3 lysfunksjoner: Høy 600lm, lav 240lm, strobe 600lm.                      Begge lyktene har magnetisk ladekabel og avtagbar hodereim.</p>	
<b>1700-AT781</b>	<p>1700lm, 3400mAh batteri 18650. 29 x 110mm.                      CREE XHP 50 LED, 6000K (kaldt lys).                      4 funksjoner: Høy 1800lm, medium 600lm, lav 100lm, ildflue 0,15lm.                      Magnetisk ladekabel, beltefeste og avtagbar hodereim. IP68.</p>	
<b>1700-AT782</b>	<p>1675lm, 3400mAh batteri 18650. 29 x 110mm.                      CREE XHP 50 LED, 4000K (varmt lys).                      4 funksjoner: Høy 1800lm, medium 600lm, lav 100lm, ildflue 0,15lm.                      Magnetisk ladekabel og avtagbar hodereim. IP68.</p>	
<b>1700-AT784</b>	<p>1000lm, 650mAh batteri 16340. 25 x 93mm.                      CREE XH-L LED                      5 funksjoner: Turbo 1000lm, høy 340lm, medium 100lm, lav 3lm, strobe 1000lm.                      USB ladekabel og festeklips for belte.                      Magnetfeste i enden. IPX8.</p>	
<b>1700-AT786</b>	<p>600lm, 700mAh batteri 16340. 21 x 55mm.                      CREE XP-L HI V3 LED                      5 funksjoner: Høy 600lm, medium 45lm, månelys 1lm, strobe 600lm, SOS 5lm.                      USB ladekabel og festeklips for belte.                      Magnetfeste i enden. IPX8.</p>	

For å se alle modeller eller andre strl., se hele vårt sortiment på [www.importex24.no](http://www.importex24.no)









## LED LOMMELYKTER / HODELYKTER / ARB. LAMPER

LED HODELYKTER / ARBEIDSLAMPER		
Best.nr.	Tekn. data	
<b>1700-AT710</b>	550lm, 2 x CR123 batterier medfølger. 4 lysfunksjoner: Høy, medium, lav, blink. IPX7.	
<b>1700-AT732</b>	280lm, Li-iom 3,7V oppladbart 2200mAa batteri. 5700K. Hengsel for vinkling, festekrok og magnetfeste. Micro USB ladekabel og docking. Ladetid ca. 3t, brukstid ca. 3t. Mål: 56 x 207x 32mm IP54.	
<b>1700-AT733</b>	400lm, 3,7V oppladbart 4000mAa batteri. 5700K. Hengsel for vinkling, festekrok og magnetfeste. Micro USB ladekabel. Ladetid ca. 4t, brukstid ca. 4,5t. Mål: 57 x 2252 x 40mm IP54.	
<b>1700-AT742</b>	3500lm, 220V / 50W. Leveres med 5m gummikabel med støpsel. Mål: 236 x 277 x 105mm. IP54	
<b>1700-AT721</b>	850lm, 6500K, 220V / 10W. Leveres med 5m gummikabel med støpsel. Festekroker for montering under panser. Justerbar! Avstand mellom kroker: 105 - 170mm. Mål: 44 x 1020 x 50mm. IP54.	

For å se alle modeller eller andre strl., se hele vårt sortiment på [www.importex24.no](http://www.importex24.no)

## BATTERIER

BATTERIER		
Best.nr.	Tekn. data	
1811-8740731	Varta AA batterier. Alkaline Longlife Leveres i 20pk.	
1811-8740730	Varta AAA batterier. Alkaline Longlife Leveres i 20pk.	
CR123A-G1	3V Lithium.	
1811-8741808	3V CR2032 / Ø 20mm.	
1811-8740250	9V Alkaline, High Energy.	
1700-AT795	3400 Li-on, oppladbart.mAh Med kortslutningsvern.	
1700-AT794	2,5A lader for oppladbare batterier. Kan lade IMR, Li-on og MI-Mh batterier med diameter fra 10 til 19mm og 30 til 70mm lengde. F.eks. AA, AAA, AAAA, 10440, 14500, 16340, 18350, 18650	

For å se alle modeller eller andre strl., se hele vårt sortiment på [www.importex24.no](http://www.importex24.no)

## LYSPÆRER

HALOGEN				
H1	Best.nr.	Stk. / pk.	Fabrikat	
12V / 55W 24V / 70W	<b>93103272</b> <b>93105106</b>	1/10/100	GE	
12V / 55W Megalight Ultra (+150%) / 2pk.	<b>93116890</b>	2/9	TUNGSRAM	
H3	Best.nr.	Stk. / pk.	Fabrikat	
12V / 55W 24V / 70W HD Long life	<b>93103598</b> <b>93105105</b>	1/10/200	GE	
HB3	Best.nr.	Stk. / pk.	Fabrikat	
12V / 60W	<b>93105080</b>	1/10/200	GE	
H4	Best.nr.	Stk. / pk.	Fabrikat	
12V / 60/55W 12V / 60/55W Long life 24V / 75/70W	<b>93103274</b> <b>93113949</b> <b>93105107</b>	1/10/100	GE	
12V / 60/55W Megalight Ultra (+150%) / 2pk.	<b>93100448</b>	2/9	TUNGSRAM	
HB4	Best.nr.	Stk. / pk.	Fabrikat	
12V / 51W	<b>93105081</b>	1/10/100	GE	
H7	Best.nr.	Stk. / pk.	Fabrikat	
12V / 55W 12V / 55W 12V / 55W Long life 24V / 70W HD Long life	<b>93103275</b> <b>35017</b> <b>93108021</b> <b>93105108</b>	1/10/100	GE	
12V / 55W Megalight (+120%) / 2pk.	<b>93098619</b>	1/10/100	GE	
12V / 55W Megalight Ultra (+150%) / 2pk.	<b>93100449</b>	2/9/	TUNGSRAM	
H8	Best.nr.	Stk. / pk.	Fabrikat	
12V / 35W (Blister)	<b>93105775</b>	1/10	GE	

For å se alle modeller eller andre strl., se hele vårt sortiment på [www.importex24.no](http://www.importex24.no)

## LYSPÆRER

HALOGEN			
H9	Best.nr.	Stk. / pk.	Fabrikat
12V / 65W	<b>93104192</b>	1/10/100	GE
H11	Best.nr.	Stk. / pk.	Fabrikat
12V / 55W	<b>93104193</b>	1/10	GE



XENON			
D1S	Best.nr.	Stk. / pk.	Fabrikat
85V / 35W / 4200K	<b>93106982</b>	1/4	GE
85V / 35W / 4300K	<b>1608-85402</b>	1	Autoline
85V / 35W / 5500K	<b>93096783</b>	1/4	GE
85V / 35W / 5000K (+50%)	<b>1608-85415</b>	1	Autoline
D1R	Best.nr.	Stk. / pk.	Fabrikat
85V / 35W / 4300K	<b>1608-85409</b>	1	Autoline
D2S	Best.nr.	Stk. / pk.	Fabrikat
85V / 35W / 4200K	<b>93106979</b>	1/8	GE
85V / 35W / 4300K	<b>1608-85122</b>	1	Autoline
85V / 35W / 5000K	<b>1608-85123</b>	1	Autoline
85V / 35W / 5500K	<b>93095970</b>	1/3	GE
D2R	Best.nr.	Stk. / pk.	Fabrikat
85V / 35W / 4200K	<b>93106978</b>	1/8	GE
85V / 35W / 4300K	<b>1608-85126</b>	1	Autoline
85V / 35W / 5000K	<b>1608-85127</b>	1	Autoline
85V / 35W / 5500K	<b>93095514</b>	1/3	GE
D3S	Best.nr.	Stk. / pk.	Fabrikat
42V / 35W / 4300K	<b>1608-85403</b>	1/8	Autoline
85V / 35W / 4800K	<b>93095512</b>	1	GE
42V / 35W / 5000K	<b>1608-85404</b>	1	Autoline
D3R	Best.nr.	Stk. / pk.	Fabrikat
42V / 35W / 4200K	<b>93106976</b>	1	GE
D4S	Best.nr.	Stk. / pk.	Fabrikat
42V / 35W / 4800K	<b>42402T</b>	1	Toshiba
85V / 35W / 4200K	<b>93095513</b>	1/3	GE
D4R	Best.nr.	Stk. / pk.	Fabrikat
85V / 35W / 4200K	<b>93106564</b>	1/3	GE







For å se alle modeller eller andre strl., se hele vårt sortiment på [www.importex24.no](http://www.importex24.no)

## LYSPÆRER

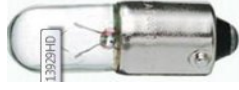

ASYMETRISK			
P45T	Best.nr.	Stk. / pk.	Fabrikat
12V / 45/40W	12620	1/10	Autoline



KONTROLL OG PARKLYS			
Sokkel BA9s	Best.nr.	Stk. / pk.	Fabrikat
12V / 2W	12913	10	Autoline
12V / 4W	93103618	10/200	GE
24V / 2W	13913	10	Autoline
24V / 4W	93103617	10/200	GE
24V / 4W HD	93107996	10	GE
Sokkel BAX9s	Best.nr.	Stk. / pk.	Fabrikat
12V / 6W Long life	93111377	1/10/100	GE
Glassokkel W2	Best.nr.	Stk. / pk.	Fabrikat
12V / 1,2W	93103626	10/200	GE
Glassokkel W5W	Best.nr.	Stk. / pk.	Fabrikat
12V / 3W	93108006		GE
12V / 5W	93103623		GE
24V / 5W	93106969		GE
12V / 5W Orange	93103624		GE

STOPP, BAK, BLINKLYS			
Sokkel BA15s	Best.nr.	Stk. / pk.	Fabrikat
12V / 5W	93103608	10/200	GE
12V / 10W	93103609	10/200	GE
24V / 5W	93103610	10/200	GE
24V / 5W Long life	93095324	10/200	GE
24V / 10W Long Life	93095977	10/200	GE
12V / 21W	93103601	10/200	GE
12V / 21W	93088857	1/10/200	GE
24V / 21W	93104296	10/200	GE
24V / 21W	93111371	1/10/200	GE
Sokkel BAY15d	Best.nr.	Stk. / pk.	Fabrikat
12V / 21/5W Long life	93088859	1/10/200	GE
24V / 21/5W	93103605		GE
Sokkel BAZ15d	Best.nr.	Stk. / pk.	Fabrikat
12V / 21W	93103606	10/200	GE
12V 21/4W Long life	93108020	1/10/200	GE
Sokkel BAU15s	Best.nr.	Stk. / pk.	Fabrikat
12V / 21W Orange	93088712	1/10/200	GE
24V / 21W Orange	93097343	10/200	GE

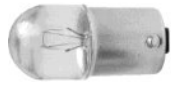
SOFITTEN PÆRER			
Sokkel SV8,5-8	Best.nr.	Stk. / pk.	Fabrikat
12V / 5W (11x36mm)	93108002	1/10/200	GE
12V / 10W (11x41mm)	93108003	1/10/200	GE



For å se alle modeller eller andre strl., se hele vårt sortiment på [www.importex24.no](http://www.importex24.no)



## LYSPÆRER

MINI HALOGEN			
Sokkel BA9s	Best.nr.	Stk. / pk.	Fabrikat
12V / 10W	93111370	1/20	GE
Sokkel BAX9s	Best.nr.	Stk. / pk.	Fabrikat
12V / 6W	93105097	1/10/100	GE



LYSPÆRER LED			
H1	Best.nr.	Stk. / pk.	Fabrikat
12-24V / 25W / 5000K ECE-R10 Kun for offroad	1608-86001	1	Autoline
H3	Best.nr.	Stk. / pk.	Fabrikat
12-24V / 25W / 5000K ECE-R10 Kun for offroad	1608-86003	1	Autoline
H4	Best.nr.	Stk. / pk.	Fabrikat
12-24V / 25W / 5000K ECE-R10 Kun for offroad	1608-86004	1	Autoline
H7	Best.nr.	Stk. / pk.	Fabrikat
12-24V / 25W / 5000K ECE-R10 Kun for offroad	1608-86007	1	Autoline
H8	Best.nr.	Stk. / pk.	Fabrikat
12-24V / 25W / 5000K ECE-R10 Kun for offroad	1608-86008	1	Autoline
H9	Best.nr.	Stk. / pk.	Fabrikat
12-24V / 25W / 5000K ECE-R10 Kun for offroad	1608-86009	1	Autoline
H11	Best.nr.	Stk. / pk.	Fabrikat
12-24V / 25W / 5000K ECE-R10 Kun for offroad	1608-86011	1	Autoline



Hvis LED pærer blinker bruk motstand: H1: 1605-1542, H4: 1605-1543, H7: 1605-1544

For å se alle modeller eller andre strl., se hele vårt sortiment på [www.importex24.no](http://www.importex24.no)

## LYSPÆRER

LED KONTROLL OG PARKLYS				
Sokkel W2,1x9,5d	Best.nr.	Stk. / pk.	Fabrikat	Erstatter
12V / 0,5W / 4000K	<b>93080380</b>	2/20	Tungsrø	3W og 5W
12V / 0,5W / 6000K	<b>93074321</b>	2/20	Tungsrø	3W og 5W
Sokkel BA9s	Best.nr.	Stk. / pk.	Fabrikat	Erstatter
12V / 4W	<b>BA9SLED-VAL</b>	2	Autoline	

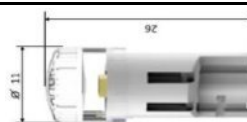

LED BLINKLYS				
Sokkel BA15s	Best.nr.	Stk. / pk.	Fabrikat	Erstatter
12V / 3W / 4000K	<b>93116985</b>	1/10	Tungsrø	21W
12V / 3W / 6000K	<b>93116984</b>	1/10	Tungsrø	21W
LED STOPP, BAK				
Sokkel BAY15d	Best.nr.	Stk. / pk.	Fabrikat	Erstatter
12V / 3/0,55W / 4000K	<b>93117017</b>	1/10	Tungsrø	21W og 5W
12V / 3/0,55W / 6000K	<b>93117016</b>	1/10	Tungsrø	21W og 5W



LED SOFITTE PÆRER				
Sokkel SV8,5-8	Best.nr.	Stk. / pk.	Fabrikat	Erstatter
12V / 0,5W / 11X36MM 4000K	<b>93108744</b>	1/10	Tungsrø	
12V / 0,5W / 11X36MM 6000K	<b>93108743</b>	1/10	Tungsrø	
12V / 0,5W / 11X41MM 4000K	<b>93095655</b>	1/10	Tungsrø	
12V / 0,5W / 11X41MM 6000K	<b>93095654</b>	1/10	Tungsrø	
12V / 0,5W / 9X31MM 4000K	<b>93116983</b>	1/10	Tungsrø	
12V / 0,5W / 9X31MM 6000K	<b>93116982</b>	1/10	Tungsrø	



PÆRESKAP	
Beskrivelse	Best.nr.
<p>Leveres med 5 skuffer med gjennomsiktig front. Innebygd LED lyslist øverst i skapet som lyser ned i uttrekt skuff.</p> <p>Medfølger omformer og det er AV / PÅ bryter bak på skapet. Feste for veggmontering. Mål: 35 X 89 X 63cm.</p>	<b>NM1025</b>



For å se alle modeller eller andre strl., se hele vårt sortiment på [www.importex24.no](http://www.importex24.no)

## PUMPER

DRIVSTOFF PUMPER		
Best.nr.	Tekn. data	
1800-48008	Håndpumpe. Leveres med 8mm slange.	
DRIVSTOFF PUMPER		
Best.nr.	Tekn. data	
18812	12V. Universalpumpe drivstoff. 130l Pr. t./maks løftehøyde 4,5m /0,35Bar. 8mm nippler	
18824	24V. Universalpumpe drivstoff. 130l Pr. t./maks løftehøyde 4,5m /0,35Bar. 8mm nippler	
Elektrisk drivstoffpumpe i stål utførelse med vendbare 8mm stål-nippler. Monteres valgfritt ved tank eller motorrom. Sugehøyde ved montering ved motor ca. 1,5meter. Skyvehøyde ved montering ved tank ca. 3 meter. 130L pr. time ved 0 høydeforskjell. Mer høyde gir mindre L.pr.t.		
DRIVSTOFF PUMPER		
Best.nr.	Tekn. data	
240-22174	12V. Universal drivstoffpumpe for Yanmar. Erstatter Yanmar: 129612-52100	
BUNKRINGS PUMPER		
Best.nr.	Tekn. data	
8300-0715	12V / 150W 40l. Pr. min. ved null høydeforskjell. Mer høyde gir mindre l. pr. time. Maks sugehøyde 5m. / 3bar.	
8300-0716	24V / 150W 40l. Pr. min. ved null høydeforskjell. Mer høyde gir mindre l. pr. time. Maks sugehøyde 5m. / 3bar.	
PUMPE FOR OLJESKIFT		
Best.nr.	Tekn. data	
1798-0403009	12V pumpe for oljeskift. 1,8m kabel med batteri klyper og slange inkl. Kan gå kontinuerlig og tåler å gå tørr. 6 amp. sikring.	

For å se alle modeller eller andre strl., se hele vårt sortiment på [www.importex24.no](http://www.importex24.no)

## PUMPER

VANNKRAN MED MANUELL PUMPE		
Best.nr.	Tekn. data	
1800-7162	Manuell vannkran. Mål: 166 x 159mm. Maks 3,8L/ min. For 9,5mm. slange.	
VANNKRAN MED ELEKTRISK PUMPE		
Best.nr.	Tekn. data	
1800-06301	Minipumpe 12V. 6,6l pr. min. For 10mm slange. Maks pumpehøyde 2m. Leveres med festeklemmer.	
MINIPUMPE		
Best.nr.	Tekn. data	
1800-06302	Minipumpe 12V. 6,6l pr. min. For 10mm slange. Maks pumpehøyde 2m. Leveres med festeklemmer.	
SIRKULASJONSPUMPE		
Best.nr.	Tekn. data	
9000-1015	12V. Sirkulasjonspumpe for vann. 15l pr. min./ 0,15 bar trykk. For 16mm slange. Mål: 42mm x 175mm.	
9000-1077	24V. Sirkulasjonspumpe for vann. 15l pr. min./ 0,15 bar trykk. For 16mm slange. Mål: 42mm x 175mm.	
LENSEPUMPE		
Best.nr.	Tekn. data	
1800-716	Manuell lensepumpe for vann. Maks 45l pr. min. For slange, inn34mm / ut 38mm. Mål: 273 x 140 x 140mm.	

For å se alle modeller eller andre strl., se hele vårt sortiment på [www.importex24.no](http://www.importex24.no)



## PUMPER

LENSEPUMPE	
Best.nr.	Tekn. data
1800-30605-12V	Automatisk lensepumpe for vann. Maks pumpehøyde 2,5m. Maks 31L/ min. Mål: 136 x 82 x 110mm.
1800-30605-24V	Automatisk lensepumpe for vann. Maks pumpehøyde 2,5m. Maks 31L/ min. Mål: 136 x 82 x 110mm.
	
LENSEPUMPE	
Best.nr.	Tekn. data
1800-30610-12V	12V Automatisk lensepumpe for vann. Maks pumpehøyde 4m. Maks 63L/ min. For 29mm slange. Mål: 165 x 96 x 130mm.
1800-30610-24V	24V Automatisk lensepumpe for vann. Maks pumpehøyde 4m. Maks 63L/ min. For 29mm slange. Mål: 165 x 96 x 130mm.
	
LENSEPUMPE	
Best.nr.	Tekn. data
1800-30615-12V	12V Automatisk lensepumpe for vann. Maks pumpehøyde 4m. Maks 95L/ min. For 29mm slange. Mål: 190 x 108 x 150mm.
1800-30615-24V	24V Automatisk lensepumpe for vann. Maks pumpehøyde 4m. Maks 95L/ min. For 29mm slange. Mål: 190 x 108 x 150mm.
	
AUTOMATISK BRYTER FOR LENSEPUMPE	
Best.nr.	Tekn. data
1800-0812202	12 / 24V. Maks 10A.
	

For å se alle modeller eller andre strl., se hele vårt sortiment på [www.importex24.no](http://www.importex24.no)



## PUMPER

LENSE / GRÅVANNS PUMPE	
Best.nr.	Tekn. data
1798-0301001	12V / Maks 22L. min. Trenger ikke filter Pumpehøyde inntil: 2,5m. Stillegående og lavt strømforbruk. 4,5A Inn / Ut kan roteres 360 Tilkobling for 19mm og 25mm slange. Mål: 141 x 105 x 140mm. Vekt: 0,8kg.

albin.pump  
marine



LENSE / GRÅVANNS PUMPE	
Best.nr.	Tekn. data
1798-0301005	12V / Maks 22L. min. Utstyrt med rotasjonskniv for avløpsvann. Pumpehøyde inntil 4m. Inntak: 38mm / Utløp: 25mm. Innvendige deler i messing og rustfritt stål. Sikring: 7A. Mål: 240 x 90 x 130mm. Vekt: 1,98kg.

albin.pump  
marine



BRYTERPANEL FOR LENSEPUMPER	
Best.nr.	Tekn. data
1800-0240301	12V. Auto / Off / Manuell. Mål: 88 x 118mm.







For å se alle modeller eller andre strl., se hele vårt sortiment på [www.importex24.no](http://www.importex24.no)

## HÅNDPUMPER

HÅNDPUMPER		
Best.nr.	Bosch nr.	
48000	2447222000 2447222016 2447222099 2447222746	 Gj: 16 x 1,5mm
48022-05	2447010033 2447701038 2447222125 2447222126	 Gj: 16 x 1,5mm
53111005	Gjennomstrømning i brakett maks 250l.pr. time. Har returventil 14 x 1,5 inn/ut.	 107mm Gj: 14 x 1,5mm
49265	0440011007	 Gj: 14 x 1,5mm
KOMPLETT FILTER		
Best.nr.	Bosch nr.	
48049	1457434000	
GLASS / FILTER FOR BCD 080/B		
48066	2447010017 9441070044 9441080044	
48061	2447010004 244701004S S02362	

For å se alle modeller eller andre strl., se hele vårt sortiment på [www.importex24.no](http://www.importex24.no)

## FILTER OG FILTERHOLDERE

DRIVSTOFF FILTER										
Best.nr.	Erstatter									
<b>H101WK</b>	Fram: G-4164 Purolator: F57608 <b>NB: BRUKES KUN PÅ BENSIN</b>									
<b>H102WK</b>	Fram: P-4174, P6446 Mercedes: 0014772101, 0014773301, 0014774201, 0014775601, 0014776901 Purolator: F5768 <b>NB: BRUKES KUN PÅ DIESEL</b>									
KOMLETT HOLDER MED SIL										
Best.nr.	Beskrivelse									
<b>FT-050</b>	Inn: 14x1,5mm, høyre side Ut: 14x1,5mm, venstre side									
<b>FT-051</b>	Inn: 14x1,5mm, høyre side Ut: 14x1,5mm, venstre side									
FILTERHOLDERE FOR DRIVSTOFF FILTER										
Erstatter: Bosch: 0450133007, 0450122011, 0450133013, 0450198009 Case: 5148524, 5181823 Volvo: 8107486, 838472, 1542209  Følgende filter kan brukes: H17WK02 H30WK01 H60WK01-07 H70WK02 m/tapping 33192 m/tapping <b>Leveres uten blindplugger! / (7097-81Q)</b>		<table style="width: 100%; border: none;"> <tr> <td style="width: 50%;"></td> <td style="text-align: right;"><b>280 l. pr/t.</b></td> </tr> <tr> <td></td> <td style="text-align: right;"><b>105 l. pr/t.</b></td> </tr> <tr> <td></td> <td style="text-align: right;"><b>165 l. pr/t.</b></td> </tr> <tr> <td></td> <td style="text-align: right;"><b>165 l. pr/t.</b></td> </tr> </table>		<b>280 l. pr/t.</b>		<b>105 l. pr/t.</b>		<b>165 l. pr/t.</b>		<b>165 l. pr/t.</b>
	<b>280 l. pr/t.</b>									
	<b>105 l. pr/t.</b>									
	<b>165 l. pr/t.</b>									
	<b>165 l. pr/t.</b>									
Alle er på ca. <b>5MY</b>		 <p style="text-align: center;">Gjenger for filter 16 x 1,5mm. Gjenger inn / ut: 14 x 1,5mm.</p> <div style="border: 1px solid black; padding: 2px; width: fit-content; margin: auto;"> <b>Best.nr.: 49102</b> </div>								

For å se alle modeller eller andre strl., se hele vårt sortiment på [www.importex24.no](http://www.importex24.no)

## FILTER OG FILTERHOLDERE

### FILTERHOLDERE FOR DRIVSTOFF FILTER

Følgende filter kan brukes:

H19WK02

TF1652 med 36 x 1,5mm hull for sensor

Nippler for 8mm. slange rett ut: 3823-0508

Nippler for 10mm. slange rett ut: 3823-0608



Gjenger for filter 3/4" - 16.

Gjenger inn / ut: 1/2" NPT.

**Best.nr.: 24764**

### FILTERHOLDER ENKEL

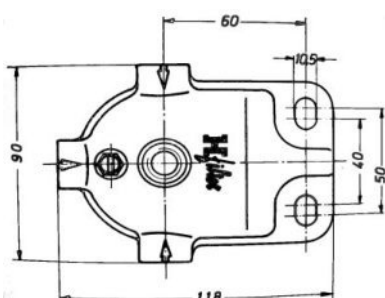

Følgende filter kan brukes:

H17WK02

H30WK01

H60WK01-07

H70WK02 m/tapping

33192 m/tapping

Alle er på ca. 5MY

280 l. pr/t.

105 l. pr/t.

165 l. pr/t.

165 l. pr/t.



Gjenger for filter: 16 x 1,5mm

Gjenger inn / ut: 14 x 1,5mm

Kun holder uten filter og blindplugger / (7097-81Q)

**Best.nr.: 49103**

### FILTERHOLDER DOBBEL MED VENDER

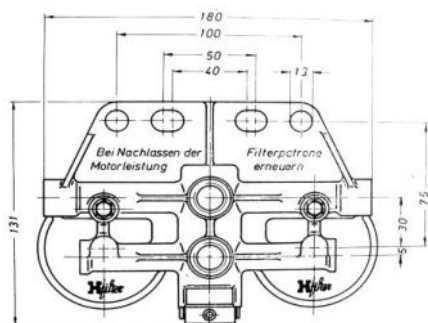

Gjenger inn / ut: 18 x 1,5mm

Gjenger på filter: 16 x 1,5mm

Følgende filter kan brukes:

H17WK02

H30WK01

H60WK01-07

H70WK02 m/tapping

33192 m/tapping

Alle er på ca. 5MY

Kun holderen: HWKU49

280 l. pr/t.

105 l. pr/t.

165 l. pr/t.

165 l. pr/t.



Holderen leveres komplett som på bildet med filter (H70WK02), og nippler for 8mm. Slange

**Best.nr.: HWKU49-komplett**

For å se alle modeller eller andre strl., se hele vårt sortiment på [www.importex24.no](http://www.importex24.no)

## FILTER OG FILTERHOLDERE

### BRACKETT MED HÅNDPUMPE OG SIL



Følger med en blindplugg for valgfri ut

VASKBAR SIL  
MAKS 300L. PR. TIME

Best. Nr.: H11K02

INN/ UT: 14 x 1.5mm

Best. Nr.: H11K09

INN/ UT: 16 x 1.5mm

### FILTERHOLDER MED HÅNDPUMPE FOR DIESEL

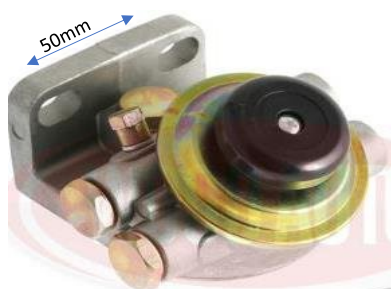

To muligheter for inn og ut.  
Inn / ut: 14 x 1.5mm  
Gjenger på filter: 16 x 1,5mm

Erstatter:

Bosch 0450126190L  
0450126190MP

Følgende filter kan brukes:

H17WK02 280 l. pr/t.

H30WK01 105 l. pr/t.

H60WK01-03 165 l. pr/t.

H70WK02 m/tapp 165 l. pr/t.

33192 m/tapp

Alle er på ca. 5MY

**NB!**

Denne holderen kan leveres som komplett med filter og nippler for 8mm slange

Best. Nr. S09794-komplett

Best. Nr.: S09794



To muligheter for inn og ut.  
Inn / ut: 14 x 1.5mm  
Gjenger på filter: 16 x 1,5mm

Erstatter:

Bosch 0450126009L  
0450126009MP

Følgende filter kan brukes:

H17WK02 280 l. pr/t.

H30WK01 105 l. pr/t.

H60WK01-03 165 l. pr/t.

H70WK02 m/tapp 165 l. pr/t.

33192 m/tapp

Alle er på ca. 5MY

**NB!**

Denne holderen kan leveres som komplett med filter og nippler for 8mm slange

Best. Nr. S09795-komplett

Best. Nr.: 49100

### CAV FILTERHOLDER MED HÅNDPUMPE FOR DIESEL



To muligheter for inn og ut.  
Inn / ut: 14 x 1.5mm

Erstatter:

CAV 9001-742A

CAV 9001-742B

CAV 9001-742G

SF112KU

Best. Nr.: 49090-04

For å se alle modeller eller andre strl., se hele vårt sortiment på [www.importex24.no](http://www.importex24.no)



## FILTER OG FILTERHOLDERE

### CAV FILTERHOLDER KOMPLETT MED HÅNDPUMPE, FILTER OG GLASS



**Erstatter:** CAV 9100-742G

To muligheter for inn / ut 14 x 1,5mm.

**Best.nr.: 49277**

Samme som 49090-4 men levert komplett med filter og glass.

### CAV FILTERHOLDERE



**Erstatter:** CAV 5836B230

Gjenger inn / ut: 1/2"-20 UNF

Kapasitet: 45 l pr/t.

Komplett filterholder levert med originalt CAV-filter

**Best. Nr.: SF108**

Erstatningsfilter for CAV 296

**E75KD42 (Hengst)**

Komplett filterholder tilsvarende denne med 14x1.5mm gjenger.

**Best. Nr.: 49218**

**Erstatter:** CAV 5838-280, SF103

Erstatningsfilter for CAV 296

**E75KD42 (Hengst)**

Glass til denne holderen: 49141

Tappeplugg: 49157 (plast eller metall)



**Erstatter:** CAV 5836B710, SF105

Gjenger inn / ut: 1/2"-20 UNF

Kapasitet: 45 l pr/t.

Komplett filterholder levert med originalt CAV-filter

**Best. Nr.: 49224**

Erstatningsfilter for CAV 296

**E75KD42 (Hengst)**

Tappeplugg: 49157 plast  
49157 metall

For å se alle modeller eller andre strl., se hele vårt sortiment på [www.importex24.no](http://www.importex24.no)

## FILTER OG FILTERHOLDERE

### CAV FILTERHOLDERE

**Erstatter:**

CAV	5836B100
Volvo Penta	1140639
	SF107

Gjenger inn / ut: 1/2"-20 UNF

Kapasitet: 45 l pr/t.

Komplett filterholder levert  
med originalt CAV-filter

**Best. Nr.: 49226**

Erstatningsfilter for CAV 296

**E75KD42 (Hengst)**

Glass til denne holderen

Best. Nr.: 49143-10

Tappeplugg: 49157 plast  
49157 metall



Komplett filterholder tilsvarende  
49226, men med metall kopp  
og tappeskruer

**Erstatter:**

CAV	5836B900
Volvo Penta	3582493

Gjenger inn / ut: 1/2"-20 UNF

Kapasitet: 45 l pr/t.

Levert med originalt CAV-filter

**Best. Nr.: SF111**

Erstatningsfilter for CAV 296

**E75KD42 (Hengst)**

Tappeplugg: 49157 plast  
49157 metall

For å se alle modeller eller andre strl., se hele vårt sortiment på [www.importex24.no](http://www.importex24.no)

## FILTER OG FILTERHOLDERE

### CAV VANNUTSKILLER.

**Erstatter:**

CAV 2656086G

Gjenger inn / ut: 1/2"-20 UNF

Tappeplugg: 49157 plast  
49157 metall

**Best. Nr.: SF301A**

### VANNSEPERATOR FOR DIESEL



Gjenger inn / ut: 14x1.5mm

Kapasitet: 240 l pr/t.

**Best. Nr.: H210K**

For å se alle modeller eller andre strl., se hele vårt sortiment på [www.importex24.no](http://www.importex24.no)

## FILTER OG FILTERHOLDERE

### FILTERHOLDER FOR OLJEFILTER

**Brukes for å flytte oljefilter med 3/4"- 16 gjenger til annen plassering.**



**Best.nr.: 24730**

Gjenger ut av motor: 3/4" - 16  
Gjenger slangenippel: 1/2" NPT



**Best.nr.: 24764**

Gjenger for filter 3/4"-16  
Gjenger slangenippel: 1/2" NPT

**Man monterer 24730 på motorens opprinnelige filterbrakett og slanger derfra til 24764.  
Leveres med filter H10W01.**

**Man kan også bruke filter: H14W04, H16W02, H17W01, H17W06, H19W03, H19W04, 51515.  
Nippler for 16mm. slange rett ut er varenr. 3823-1008.**

**Brukes for å flytte oljefilter med 20 x 1,5 mm. gjenger til annen plassering.**



**Best.nr.: 24736**

Gjenger ut av motor: 20x1,5mm  
Gjenger slangenippel: 1/2" NPT



**Best.nr.: 24764**

Gjenger for filter 3/4"-16  
Gjenger slangenippel: 1/2" NPT

**Man monterer 24736 på motorens opprinnelige filterbrakett og slanger derfra til 24764.  
Leveres med filter H10W01.**

**Man kan også bruke filter: H14W04, H16W02, H17W01, H17W06, H19W03, H19W04.  
Nippler for 16mm. slange rett ut er varenr. 3823-1008.**

**For å se alle modeller eller andre strl., se hele vårt sortiment på [www.importex24.no](http://www.importex24.no)**

## FILTER OG FILTERHOLDERE

### FILTER TENGER

Best.nr.:	Beskrivelse.
1716-601024	Filtertang med reim.

 **UNIORD**



Best.nr.:	Beskrivelse.
1716-601025	Filtertang med kjede.

 **UNIORD**



### RETURVENTIL



Returventil for slange	Best.nr.:
6 mm Slange	<b>56101</b>
8 mm Slange	<b>56102</b>
10 mm Slange	<b>56103</b>

For å se alle modeller eller andre strl., se hele vårt sortiment på [www.importex24.no](http://www.importex24.no)



## SLANGER OG TILBEHØR

### UTVENDIG NBR GUMMI/INNVENDIG TEKSTILFLETING DIN 73379E. TEMP. OMRÅDE -40/+150°C. ARB.TRYKK 5-50 BAR.

Best.nr.	Innv. dia.	Utv. dia.	Rull
<b>2820209</b>	3,2	9,0	15m.
<b>28040</b>	4,0	9,0	15m.
<b>28050</b>	5,0	11,0	15m.
<b>28060</b>	6,0	12,0	15m.
<b>28060B</b>	6,0	12,0	20m. (Bunt)
<b>28080</b>	8,0	14,0	15m.
<b>28080B</b>	8,0	14,0	20m. (Bunt)
<b>28100</b>	10,0	16,0	10m.
<b>28100B</b>	10,0	16,0	20m. (Bunt)
<b>28120</b>	12,0	19,0	5 m



### UTVENDIG TEKSTILFLETING/INNVENDIG NBR GUMMI DIN 73379B. TEMP. OMRÅDE -40/+150°C. ARB.TRYKK 5-50 BAR.

Best.nr.	Innv. dia.	Utv. dia.	Rull
<b>2510207</b>	3,2	7,0	20m.
<b>2510207B</b>	3,2	7,0	20m. (Bunt)
<b>25102</b>	3,5	7,5	20m.
<b>25102B</b>	3,5	7,5	20m. (Bunt)
<b>25103</b>	4,5	9,5	15m.
<b>25104</b>	5,5	10,5	15m.
<b>25106</b>	7,5	12,5	15m.
<b>25108</b>	9,0	14,0	10m.
<b>25108B</b>	9,0	14,0	20m. (Bunt)



Tåler innblanding av inntil 20% biodiesel.

## VAKUMSLANGE

### NBR GUMMI DIN 73379. TEMP. OMRÅDE -40/+150°C. ARB.TRYKK 0-2 BAR.

Best.nr.	Innv. dia.	Utv. dia.	Rull
<b>27030</b>	3,0	7,0	20m.
<b>27040</b>	4,0	9,0	20m.
<b>27050</b>	5,0	10,0	20m.



### SLANGEKLEMMER ABA GALVANISERT STÅL

Best.nr.	Spennområde	Båndbredde
<b>1712-101008</b>	8	9
<b>1712-101009</b>	9	9
<b>1712-101010</b>	10	9
<b>1712-101011</b>	11	9
<b>1712-101012</b>	12	9
<b>1712-101013</b>	13	9
<b>1712-101014</b>	14	9
<b>1712-101015</b>	15	9
<b>1712-101016</b>	16	9
<b>1712-101017</b>	17	9



Galvanisert stål S10

For å se alle modeller eller andre strl., se hele vårt sortiment på [www.importex24.no](http://www.importex24.no)

## SLANGER OG TILBEHØR

### ASS. SLANGEKLEMMSETT 120 DELER M/ SKRUTREKKER, ABA GALVANISERT STÅL

Best.nr.	Inneholder
<b>1712-026014</b>	15 stk. - 1712-101008
	15 stk. - 1712-101009
	30 stk. - 1712-101010
	10 stk. - 1712-101011
	30 stk. - 1712-101012
	10 stk. - 1712-101013
	5 stk. - 1712-101014
	5 stk. - 1712-101015

**ABA**



### SLANGEKLEMMER ABA ALUZINK STÅL

Best.nr.	Spennområde	Båndbredde
<b>1712-108011</b>	8-14	9
<b>1712-108014</b>	11-17	9
<b>1712-108017</b>	13-20	9
<b>1712-001020</b>	15-24	12
<b>1712-001024</b>	19-28	12
<b>1712-001027</b>	22-32	12
<b>1712-001032</b>	26-38	12
<b>1712-001038</b>	32-44	12
<b>1712-001044</b>	38-50	12
<b>1712-001050</b>	44-56	12
<b>1712-001058</b>	50-65	12

**ABA**



Aluzink S20. DIN3017

3 ganger mer motstand mot korrosjon enn galvanisert stål

### ASS. SLANGEKLEMMSETT 244 DELER M/ SKRUTREKKER, ABA GALV. OG ALUZINK STÅL

Best.nr.	Inneholder
<b>1712-026009</b>	10 stk. - 1712-101008
	10 stk. - 1712-101009
	10 stk. - 1712-101010
	10 stk. - 1712-101011
	10 stk. - 1712-101012
	10 stk. - 1712-101013
	10 stk. - 1712-101014
	10 stk. - 1712-101015
	10 stk. - 1712-101016
	10 stk. - 1712-101017
	12 stk. - 1712-108011
	12 stk. - 1712-108014
	12 stk. - 1712-108017
	24 stk. - 1712-001020
	12 stk. - 1712-001024
	12 stk. - 1712-001027
	12 stk. - 1712-001032
	12 stk. - 1712-001038
	12 stk. - 1712-001044
	12 stk. - 1712-001050
12 stk. - 1712-001058	



**ABA**



For å se alle modeller eller andre strl., se hele vårt sortiment på [www.importex24.no](http://www.importex24.no)

## SLANGER OG TILBEHØR

SLANGEKLEMMER ABA SYREFASTE		
Best.nr.	Spennområde	Båndbredde
1712-6112011	8-14	9
1712-6112014	11-17	9
1712-6112017	13-20	9
1712-034020	15-24	12
1712-034024	19-28	12
1712-034027	22-32	12
1712-034032	26-38	12
1712-034038	32-44	12
1712-034044	38-50	12
1712-034050	44-56	12
1712-034058	50-65	12
1712-034067	58-75	12
1712-034077	68-85	12







Syreresistent S50.  
Rustfritt stål SS2343 / AISI316

SKRUTREKKER FOR SLANGEKLEMMER	
Best.nr.	Beskrivelse
1714-V4665	Fleksibel skrutrekker for slangeklemmer.



For å se alle modeller eller andre strl., se hele vårt sortiment på [www.importex24.no](http://www.importex24.no)

## FITTINGS FOR RØR OG SLANGER

HULLSKRUER			
Best.nr.	Gjenger mm.		
HS1	6x1		
89103	8x1		
89104	10x1		
HS4/1,5	10x1,5		
89106	12x1,5		
89108	14x1,5		
89110	16x1,5		
89113	18x1,5		
853-1/2"	1/2"x20		
DOBBLE HULLSKRUER			
Best.nr.	Gjenger mm.		
89203	8x1		
89204	10x1		
89206	12x1,5		
89208	14x1,5		
89213	18x1,5		
BANJOER			
Best.nr.	For slange	Passer hull skr.	
88102	4mm.	6mm.	
88103	5mm.	8mm.	
88104	6mm.	10mm.	
8810604	6mm.	12mm.	
8810804	6mm.	14mm.	
88106	8mm.	12mm.	
8810806	8mm.	14mm.	
88108	10mm.	14mm.	
8811008	10mm.	16mm.	
8811308	10mm.	18mm.	
88110	12mm.	16mm.	
DOBBLE BANJOER			
Best.nr.	For slange	Passer hull skr.	
8820303	5mm.	8mm.	
8820404	6mm.	10mm.	
8820606	8mm.	12mm.	
8820808	10mm.	14mm.	
LODDEBANJOER			
Best.nr.	For rør	Passer hull skr.	
98104	6mm.	10mm.	
9810806	8mm.	14mm.	
98108	10mm.	14mm.	
SLANGENIPLER			
Best.nr.	For slange	Gjenger mm.	
857550600	8mm.	14x1,5	
80510600	8mm.	14x1,5	
80510800	10mm.	16x1,5	

For å se alle modeller eller andre strl., se hele vårt sortiment på [www.importex24.no](http://www.importex24.no)







## FITTINGS FOR RØR OG SLANGER

<b>SLANGENIPPLER</b>				
Best.nr.	For slange	For muttertype		
81004	6mm.	83004		
81006	8mm.	83006		
81008	10mm.	83008		
<b>LODDENIPPEL</b>				
Best.nr.	For rør			
91008	10mm.			
<b>MUTTERE M/FLATT SETE FOR LODDE- OG SLANGENIPPLER</b>				
Best.nr.		Gjenger mm.	Boring	
83003	5mm.	10x1	6,5	
83004	6mm.	12x1,5	7,5	
83006	8mm.	14x1,5	9,5	
<b>SLANGENIPPLER</b>				
Best.nr.	For slange	Utv. dia.		
86104	6mm.	6mm.		
86106	8mm.	8mm.		
86108	10mm.	10mm.		
<b>SLANGENIPPLER 90 GRADER</b>				
Best.nr.	For slange	L1/L2		
86604	6mm.	25/30		
86606	8mm.	30/35		
<b>T-SLANGENIPPLER</b>				
Best.nr.	For slange			
000121	4-5mm.			
000122	5-6mm.			
000123	7-8mm.			
000124	9-10mm.			
<b>BLINDPLUGG</b>				
Best.nr.	For slange			
7097-81Q	14x1,5			
<b>OVERGANG</b>				
Best.nr.	For slange			
HWKU051-120	Fra 18x1,5 til 14x1,5mm.			
<b>OVERSTØMSVENTIL</b>				
Best.nr.	Gjenger	Bosch		
31203	14x1,5	EPVE 232P1Z		

For å se alle modeller eller andre strl., se hele vårt sortiment på [www.importex24.no](http://www.importex24.no)



## FITTINGS FOR RØR OG SLANGER

SLANGEHYLSER			
Best.nr.	Innv. dia.		
80110	10mm		
80111	11mm		
8011252	12,5mm		
8011350	13,5mm		
8011450	14,5mm		
80116	16mm		
80117	17mm		
8011850	18,5mm		
8011950	19,5mm		
80122	22mm		
8013050	30,5mm		
PLASTHETTER FOR UTV. GJENGER			
Best.nr.	For gjenger	Stk.	
245010	10x1	100	
245012	12x1,5	"	
245014	14x1,5	"	
245016	16x1,5	"	
245018	18x1,5	"	
245022	22x1,5	"	
PLASTHETTER FOR INNV. GJENGER			
245108	8x1	100	
245110	10x1	"	
245112	12x1,5	"	
245114	14x1,5	"	
245116	16x1,5	"	
245118	18x1,5	"	
245120	20x1,5	"	
245122	22x1,5	"	
PLASTHETTER MED INNV. GJENGER			
245510	10x1	10	
245512	12x1,5	10	
245514	14x1,5	10	
245516	16x1,5	10	
PLUGG FOR DYSEHOLDER			
Best.nr.	Materiale	Antall	
S08165	Gummi	10	
110243	Slange m/metallplugg	20	



For å se alle modeller eller andre strl., se hele vårt sortiment på [www.importex24.no](http://www.importex24.no)

## FITTINGS FOR RØR OG SLANGER

### FITTINGS FOR 1/2" UNF

SLANGENIPPEL			
Best.nr.	Slange dim.	Gjenger	
88244-6mm	6mm	1/2"x20	
88244-8mm	8mm	1/2"x20	
88244-10mm	10mm	1/2"x20	
88245	8mm	1/2"x20	
HULLSKRUE			
853-1/2"	14mm	1/2"x20	
SLANGEBANJO	HULL	SLANGE	
8810804	14mm	6mm	
8810806	14mm	8mm	
88108	14mm	10mm	
BLINDPLUGG		GJENGER	
7111-312		1/2" x 20	

### FITTINGS FOR 1/2" NTP OG 3/8" NTP



SLANGENIPPEL FOR 1/2"-NTP GJ. M/ KON		
Best.nr.	Slange dim.	
3823-0508	8mm	
3823-0608	10mm	
3823-1008	16mm	
SLANGENIPPEL FOR 3/8"-NTP GJENGER		
3823-0506	8mm	
3823-0606	10mm	

### VINKELLEDD

VINKELLEDD		
Best.nr.	Gjenger	
WG5S	5x0,8	
WG6S	6x1	
WG8S	8x1,25	
WG10S	10x1,5	
WG12S	12x1,75	





For å se alle modeller eller andre strl., se hele vårt sortiment på [www.importex24.no](http://www.importex24.no)

## KOBBERINGER - DYSEPAKNINGER

KOBBERINGER Å 100STK													
Best.nr.													
<b>CU6X10X1</b> <b>CU8X12X1</b> <b>CU8X14X1</b> <b>CU9X19X2,5</b> <b>CU9.2X18.8X2</b> <b>CU9.5X20X1</b> <b>CU9.5X20X2</b> <b>CU10X14X1</b> <b>CU10X16X1</b> <b>CU10X16X1.5</b> <b>CU11X20X1</b> <b>CU12X16X1.5</b> <b>CU12X18X1.5</b> <b>CU14X18X1.5</b> <b>CU14X20X1.5</b> <b>CU14X20X2</b> <b>CU14,5X20X2</b> <b>CU16X22X1.5</b> <b>CU18X24X1.5</b> <b>CU20X23X2</b> <b>CU26X36X2</b>													
KOBBERINGER DOBBEL Å 10STK													
<b>CU6X11X1ZW</b>													
KOBBERINGER ASSORTEMENT													
<b>100500</b>													
Inneholder 1600stk kobberinger.													
<table style="width: 100%; border: none;"> <tr> <td style="width: 50%;">6X10X1</td> <td style="width: 50%;">8X12X1</td> </tr> <tr> <td>10X14X1</td> <td>10X16X1</td> </tr> <tr> <td>12X18X1,5</td> <td>14X18X1,5</td> </tr> <tr> <td>16X20X1,5</td> <td>16X22X1,5</td> </tr> <tr> <td>20X26X1,5</td> <td>22X27X1,5</td> </tr> <tr> <td>26X32X2</td> <td>28X34X2</td> </tr> </table>	6X10X1	8X12X1	10X14X1	10X16X1	12X18X1,5	14X18X1,5	16X20X1,5	16X22X1,5	20X26X1,5	22X27X1,5	26X32X2	28X34X2	
6X10X1	8X12X1												
10X14X1	10X16X1												
12X18X1,5	14X18X1,5												
16X20X1,5	16X22X1,5												
20X26X1,5	22X27X1,5												
26X32X2	28X34X2												





For å se alle modeller eller andre strl., se hele vårt sortiment på [www.importex24.no](http://www.importex24.no)

## HORN

HORN				
Best.nr.	dB	Dim. mm.	Volt	
<b>K95 12V</b> <b>K95 24V</b>	112dB 112dB	86x57 86x57	12 24	
<b>1801-24430</b>		107x55	24	
<b>921981</b> <b>921982</b>	117dB 117dB	70,5x150/190 70,5x150/190	12 24	
<b>921986</b> <b>921987</b>	117dB 117dB	70,5x150/190 70,5x150/190	12 24	
Best.nr.	Beskrivelse		Lengde	
<b>1800-1033</b>	12V, rustfritt, elektrisk.		406mm	
MARINEHORN MED KOMPRESSOR, RUSTFRITT STÅL				
Best.nr.	Volt / Amp.	dB	Lengde	
<b>LIBECCIO 12V</b>	12V - 20Amp.	114dB - 370Hz	385mm	 
<b>LIBECCIO 12V G*</b>	12V - 20Amp.	116dB	385mm	
<b>LIBECCIO 24V</b>	12V - 20Amp.	114dB - 370Hz	385mm	
<b>LIBECCIO 24V G*</b>	12V - 20Amp.	116dB	385mm	
*Libeccio horn levert som godkjent i.h.t skriv i fra sjøfartsdirektoratet for fartøy under 20 meter				

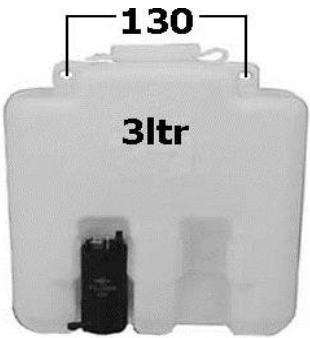
For å se alle modeller eller andre strl., se hele vårt sortiment på [www.importex24.no](http://www.importex24.no)

## VINDUSPUSSE MOTOR / SPYLING

VINDUS SPYLING		
Best.nr.	Beskrivelse	
<b>1559-19072</b>	3L tank med 12V pumpe. Mål: B,H,D: 190 x 210 x 105mm.	
<b>1559-19073</b>	3L tank med 24V pumpe. Mål: B,H,D: 190 x 210 x 105mm.	
<b>1559-246001</b>	12V spylepumpe. For 5-6mm. slange.	
<b>1559-246020</b>	24V spylepumpe. For 5-6mm. slange.	
<b>1559-150102</b>	Enkel spyledyse. For 6mm hull , 5mm slange.	
<b>1559-150101</b>	Dobbel spyledyse. For 8mm hull , 5mm slange.	
<b>1559-3187</b>	Dobbel spyledyse. For 10mm hull , 5mm slange.	
<b>1559-163001</b>	T-nippel for 5mm spyleslange.	
<b>54271025</b>	Rep.sett for spyleslanger / rør. 2,5m skjøteslange. 62 skjøtestykker. 90 O-ringer.	

For å se alle modeller eller andre strl., se hele vårt sortiment på [www.importex24.no](http://www.importex24.no)



## VINDUSPUSSE MOTOR / SPYLING

PUSSE MOTORER		
Best.nr.	Beskrivelse	
<b>WPM12V</b>	Pussermotor 12V, 110° Med autostopp. Ø6mm / L82mm aksel.	
<b>WPM24V</b>	Pussermotor 24V, 110° Med autostopp. Ø6mm / L82mm aksel.	
<b>1800-00302</b>	Pussermotor 12V, 110° Vanntett marintype. Med autostopp. Ø6mm / L92mm aksel.	
<b>1800-00007</b>	Vinduspusser arm krommet. For 280mm pusserblad og 6mm aksling.	
<b>1800-00008</b>	Vinduspusser arm krommet. For 360mm pusserblad og 6mm aksling.	
<b>1800-00014</b>	Pusserblad krommet 280mm.	
<b>1800-00015</b>	Pusserblad krommet 360mm.	

For å se alle modeller eller andre strl., se hele vårt sortiment på [www.importex24.no](http://www.importex24.no)

## BOGGILØFTEMOTORER

BOGGILØFTEMOTOR			
Best.nr.	Erstatter	Volt / Kw	
<b>9200-9919MAHLE</b> u/ thermosikring	72736272	24 / 3	
<b>9200-9950</b> m/ thermosikring	0012352295, 0136355002 0136355007, 0136355012 0136355013, 0136355014 0136355030, 0136355037 0136355038, 0136355042 0136355057, 0136355061 0136355067, 1517220500 1517220520, 1517220558 1697465, 244306, 3091555 19025744, HF1424, HF1567	24 / 2,2	
<b>9200-9955</b> m/ thermosikring	Scania, Sisu, Zebro, m.fl. 0136355081, 1375598 19024678, 24MB22TWA Erstatter også 24MB21TWA 1polet	24 / 2,2	
<b>9200-9960</b> m/ thermosikring	Volvo 0136355077, 0136355078 1698806, 3091324 3092188	24 / 1,5	
<b>9200-9988</b> u/ thermosikring	Sisu m.fl. HF1124-2, 24MC4A2WA 24MC4TWA, 24MA42TWA 24MC42TWA	24 / 3	





For å se alle modeller eller andre strl., se hele vårt sortiment på [www.importex24.no](http://www.importex24.no)

## BOGGILØFTEMOTORER

BOGGILØFTEMOTOR			
Best.nr.	Erstatter	Volt / Kw	
<b>9200-9993</b> u/ thermosikring	47041002, 47041004 47044604, 47044621 47044625, 47044628	24 / 2,1	
<b>9200-9995</b> m/thermosikring	MB Actros, Volvo FH m.fl. 1303460, 1303465 202460023, 20442030 8581180, 24MD22WA 24MD22TWA	24 / 2	
KNAPPEBOKSER			
Best.nr.	Beskrivelse		
<b>1801-5020</b>	To knapper, opp/ned. Mål: 60 x 110 x 54mm. IP65.		
<b>1801-5021</b>	Tre knapper, opp/tilt/ned. Mål: 60 x 142 x 54mm. IP65.		
<b>1804-1114</b>	Tre knapper, opp/tilt/ned. For innfelling.		
<b>MON-93862400</b>	Tre knapper, opp/tilt/ned. Leveres med 4m. Spiralkabel og veggfeste.		



For å se alle modeller eller andre strl., se hele vårt sortiment på [www.importex24.no](http://www.importex24.no)

## USB - LADEKABLER

LADEKABLER		
Best.nr.	Beskrivelse	
<b>1800-0330</b>	1,2m sort. Micro USB for smarttelefoner og nettbrett.	
<b>1800-0333</b>	2m sort. Micro USB for smarttelefoner og nettbrett.	
<b>1800-0336</b>	1,2m sort. For kobling av USB-C enhet til USB-A enhet. Hastighet opp til 5GB pr. sek. (USB 3,1 GEN1)	
<b>1800-0331</b>	1,2m hvit. For: Iphone 5/ 5C/ 5S /6/ 6+. Ipad Air/ Ipad 4gen./ Ipad mini. Ipod touch 5gen./ Ipod Nano 7gen.	
<b>1800-0334</b>	2m hvit. For: Iphone 5/ 5C/ 5S /6/ 6+. Ipad Air/ Ipad 4gen./ Ipad mini. Ipod touch 5gen./ Ipod Nano 7gen.	

For å se alle modeller eller andre strl., se hele vårt sortiment på [www.importex24.no](http://www.importex24.no)

## KAROSSERIKLIPS

KAROSSERIKLIPS		
Best.nr.	Tekn. data	
54267001	Karosseriklips for Mercedes og VAG. 16 forskjellige, totalt 185stk.	
54267002	Karosseriklips for BMW, Opel, Mercedes, Peugeot og VAG. 23 forskjellige, totalt 240stk.	
54267003	Karosseriklips for Audi, Skoda og VAG. 18 forskjellige, totalt 180stk.	

For å se alle modeller eller andre strl., se hele vårt sortiment på [www.importex24.no](http://www.importex24.no)



## DIVERSE VERKTØY

DIVERSE VERKTØY		
Best.nr.	Beskrivelse	
<b>1718-203444</b>	<p style="text-align: center;">Muttertrekker. 18V - 4A LI-ION batteri. Maks 700NM. Leveres i plastkoffert med ekstra batteri og lader.</p>	
<b>1714-V1711N</b>	<p style="text-align: center;">Verktøy for caliper stempler. Settet inneholder 23 deler. For trykkluft.</p>	
<b>1714-V3760</b>	<p style="text-align: center;">Verktøy for caliper stempler. Settet inneholder 49 deler. Manuelt.</p>	
<b>ZN12623</b>	<p style="text-align: center;">Pipe for clutch reimskiver.</p>	

For å se alle modeller eller andre strl., se hele vårt sortiment på [www.importex24.no](http://www.importex24.no)

## DIVERSE VERKTØY

DIVERSE VERKTØY		
Best.nr.	Beskrivelse	
<b>90940010</b>	Prøvelampe. 6 - 24V.	
<b>1711-UT131B</b>	<p>Universalt multimeter. Kan måle: DC Volt: 200mV - 250V. AC Volt: 200 - 250V. DC Spenning: 200uA - 10A. Motstand: 200 Ohm - 20 Mega Ohm. Diodetest, kontakt tone, batteri- testing for 1,5V-9V-12V med God/Lav/Dårlig. Støtsikker - kan tåle fall fra 2 meter. Automatisk avstengning. Blir levert med 2 x R03 batterier, testledninger og bruksanvisning. Mål: 95 x 58, Vekt: 0,473kg.</p>	
<b>1726-0410-3102</b>	Bits sett. Inneholder 30 bits. 1 magnetisk bits holder.	
<b>1726-1410-2702</b>	Bits sett. Inneholder 20 bits. 5 Piper. 1 bits holder. 1 miniskralle.	

For å se alle modeller eller andre strl., se hele vårt sortiment på [www.importex24.no](http://www.importex24.no)

## TENNPLUGGER

VI LEVERER TENNPLUGGER FRA:

BOSCH, CHAMPION, DENSO OG NGK.



**BOSCH**



**CHAMPION**

**DENSO**



**NGK**  
SPARK PLUGS

TIL ALLE TYPER KJØRETØY, MASKINER, MARINE, M.M.

Se hele vårt sortiment på [www.importex24.no](http://www.importex24.no)

TENNPLUGGHETTE	
Best.nr.	Beskrivelse
1200590	90° vinkel. Blå gummi, uten motstand. Spesielt egnet for påhengsmotorer, gressklippere, motorsager m.m.



For å se alle modeller eller andre strl., se hele vårt sortiment på [www.importex24.no](http://www.importex24.no)

# VIFTEREIMER



## Multireimer

Spor	Lengde (mm.)	Best.nr.	Spor	Lengde (mm.)	Best.nr.	Spor	Lengde (mm.)	Best.nr.
3	538	3PK538	4	975	4PK975	5	1090	5PK1090
3	560	3PK560	4	985	4PK985	5	1100	5PK1100
3	590	3PK590	4	995	4PK995	5	1110	5PK1110
3	630	3PK630	4	1000	4PK1000	5	1125	5PK1125
3	641	3PK641	4	1015	4PK1015	5	1135	5PK1135
3	648	3PK648	4	1028	4PK1028	5	1145	5PK1145
3	675	3PK675	4	1045	4PK1045	5	1150	5PK1150
3	690	3PK690	4	1052	4PK1052	5	1155	5PK1155
3	715	3PK715	4	1060	4PK1060	5	1165	5PK1165
3	735	3PK735	4	1075	4PK1075	5	1175	5PK1175
3	740	3PK740	4	1090	4PK1090	5	1190	5PK1190
3	750	3PK750	4	1100	4PK1100	5	1195	5PK1195
3	760	3PK760	4	1125	4PK1125	5	1212	5PK1212
3	780	3PK780	4	1165	4PK1165	5	1219	5PK1219
3	815	3PK815	4	1180	4PK1180	5	1225	5PK1225
3	820	3PK820	4	1213	4PK1213	5	1230	5PK1230
3	830	3PK830	4	1230	4PK1230	5	1240	5PK1240
3	850	3PK850	4	1238	4PK1238	5	1250	5PK1250
3	860	3PK860	4	1260	4PK1260	5	1255	5PK1255
3	915	3PK915	4	1270	4PK1270	5	1275	5PK1275
3	946	3PK946	4	1325	4PK1325	5	1295	5PK1295
3	1025	3PK1025	4	1470	4PK1470	5	1300	5PK1300
3	1040	3PK1040	4	1511	4PK1511	5	1310	5PK1310
4	611	4PK611	4	1520	4PK1520	5	1325	5PK1325
4	640	4PK640	4	1538	4PK1538	5	1330	5PK1330
4	648	4PK648	4	1600	4PK1600	5	1355	5PK1355
4	668	4PK668	4	1708	4PK1708	5	1360	5PK1360
4	673	4PK673	5	575	5PK575	5	1370	5PK1370
4	698	4PK698	5	698	5PK698	5	1390	5PK1390
4	706	4PK706	5	710	5PK710	5	1432	5PK1432
4	715	4PK715	5	725	5PK725	5	1450	5PK1450
4	725	4PK725	5	735	5PK735	5	1515	5PK1515
4	735	4PK735	5	775	5PK775	5	1545	5PK1545
4	755	4PK755	5	790	5PK790	5	1588	5PK1588
4	760	4PK760	5	813	5PK813	5	1592	5PK1592
4	775	4PK775	5	825	5PK825	5	1644	5PK1644
4	778	4PK778	5	830	5PK830	5	1680	5PK1680
4	785	4PK785	5	836	5PK836	5	1697	5PK1697
4	790	4PK790	5	850	5PK850	5	1720	5PK1720
4	800	4PK800	5	865	5PK865	5	1745	5PK1745
4	815	4PK815	5	875	5PK875	5	1750	5PK1750
4	820	4PK820	5	884	5PK884	5	1788	5PK1788
4	825	4PK825	5	890	5PK890	5	1800	5PK1800
4	830	4PK830	5	900	5PK900	5	1815	5PK1815
4	836	4PK836	5	905	5PK905	5	1850	5PK1850
4	841	4PK841	5	915	5PK915	5	2030	5PK2030
4	850	4PK850	5	920	5PK920	5	2063	5PK2063
4	856	4PK856	5	930	5PK930	6	675	6PK675
4	865	4PK865	5	940	5PK940	6	698	6PK698
4	875	4PK875	5	950	5PK950	6	720	6PK720
4	884	4PK884	5	955	5PK955	6	730	6PK730
4	890	4PK890	5	962	5PK962	6	737	6PK737
4	895	4PK895	5	970	5PK970	6	745	6PK745
4	900	4PK900	5	975	5PK975	6	751	6PK751
4	905	4PK905	5	985	5PK985	6	780	6PK780
4	915	4PK915	5	1000	5PK1000	6	800	6PK800
4	920	4PK920	5	1010	5PK1010	6	820	6PK820
4	925	4PK925	5	1015	5PK1015	6	841	6PK841
4	935	4PK935	5	1030	5PK1030	6	850	6PK850
4	945	4PK945	5	1040	5PK1040	6	858	6PK858
4	950	4PK950	5	1054	5PK1054	6	869	6PK869
4	954	4PK954	5	1060	5PK1060	6	875	6PK875
4	962	4PK962	5	1070	5PK1070	6	884	6PK884

For å se alle modeller eller andre strl., se hele vårt sortiment på [www.importex24.no](http://www.importex24.no)

# VIFTEREIMER



## Multireimer

Spor	Lengde (mm.)	Best.nr.	Spor	Lengde (mm.)	Best.nr.	Spor	Lengde (mm.)	Best.nr.
6	890	6PK890	6	1460	6PK1460	6	2055	6PK2055
6	894	6PK894	6	1468	6PK1468	6	2060	6PK2060
6	900	6PK900	6	1480	6PK1480	6	2065	6PK2065
6	906	6PK906	6	1513	6PK1513	6	2080	6PK2080
6	915	6PK915	6	1520	6PK1520	6	2094	6PK2094
6	923	6PK923	6	1525	6PK1525	6	2100	6PK2100
6	940	6PK940	6	1530	6PK1530	6	2120	6PK2120
6	950	6PK950	6	1540	6PK1540	6	2130	6PK2130
6	965	6PK965	6	1548	6PK1548	6	2140	6PK2140
6	976	6PK976	6	1555	6PK1555	6	2145	6PK2145
6	995	6PK995	6	1560	6PK1560	6	2155	6PK2155
6	1000	6PK1000	6	1570	6PK1570	6	2170	6PK2170
6	1015	6PK1015	6	1590	6PK1590	6	2176	6PK2176
6	1020	6PK1020	6	1600	6PK1600	6	2196	6PK2196
6	1030	6PK1030	6	1605	6PK1605	6	2213	6PK2213
6	1035	6PK1035	6	1610	6PK1610	6	2225	6PK2225
6	1038	6PK1038	6	1623	6PK1623	6	2238	6PK2238
6	1045	6PK1045	6	1640	6PK1640	6	2245	6PK2245
6	1050	6PK1050	6	1650	6PK1650	6	2253	6PK2253
6	1054	6PK1054	6	1660	6PK1660	6	2257	6PK2257
6	1063	6PK1063	6	1670	6PK1670	6	2260	6PK2260
6	1070	6PK1070	6	1675	6PK1675	6	2270	6PK2270
6	1080	6PK1080	6	1685	6PK1685	6	2285	6PK2285
6	1090	6PK1090	6	1693	6PK1693	6	2300	6PK2300
6	1100	6PK1100	6	1698	6PK1698	6	2315	6PK2315
6	1110	6PK1110	6	1705	6PK1705	6	2325	6PK2325
6	1125	6PK1125	6	1715	6PK1715	6	2355	6PK2355
6	1130	6PK1130	6	1720	6PK1720	6	2390	6PK2390
6	1138	6PK1138	6	1725	6PK1725	6	2404	6PK2404
6	1145	6PK1145	6	1733	6PK1733	6	2415	6PK2415
6	1153	6PK1153	6	1740	6PK1740	6	2445	6PK2445
6	1165	6PK1165	6	1743	6PK1743	6	2460	6PK2460
6	1180	6PK1180	6	1750	6PK1750	6	2475	6PK2475
6	1185	6PK1185	6	1755	6PK1755	6	2490	6PK2490
6	1190	6PK1190	6	1760	6PK1760	6	2498	6PK2498
6	1200	6PK1200	6	1775	6PK1775	6	2513	6PK2513
6	1205	6PK1205	6	1795	6PK1795	6	2553	6PK2553
6	1215	6PK1215	6	1805	6PK1805	6	2565	6PK2565
6	1230	6PK1230	6	1815	6PK1815	6	2585	6PK2585
6	1240	6PK1240	6	1830	6PK1830	6	2615	6PK2615
6	1250	6PK1250	6	1840	6PK1840	6	2625	6PK2625
6	1256	6PK1256	6	1863	6PK1863	6	2680	6PK2680
6	1264	6PK1264	6	1870	6PK1870	7	880	7PK880
6	1270	6PK1270	6	1880	6PK1880	7	1035	7PK1035
6	1275	6PK1275	6	1885	6PK1885	7	1043	7PK1043
6	1293	6PK1293	6	1890	6PK1890	7	1076	7PK1076
6	1306	6PK1306	6	1900	6PK1900	7	1088	7PK1088
6	1318	6PK1318	6	1910	6PK1910	7	1105	7PK1105
6	1325	6PK1325	6	1920	6PK1920	7	1122	7PK1122
6	1340	6PK1340	6	1930	6PK1930	7	1148	7PK1148
6	1352	6PK1352	6	1950	6PK1950	7	1165	7PK1165
6	1360	6PK1360	6	1955	6PK1955	7	1275	7PK1275
6	1370	6PK1370	6	1960	6PK1960	7	1290	7PK1290
6	1376	6PK1376	6	1980	6PK1980	7	1370	7PK1370
6	1390	6PK1390	6	1985	6PK1985	7	1380	7PK1380
6	1395	6PK1395	6	1990	6PK1990	7	1516	7PK1516
6	1400	6PK1400	6	2000	6PK2000	7	1535	7PK1535
6	1413	6PK1413	6	2013	6PK2013	7	1550	7PK1550
6	1420	6PK1420	6	2020	6PK2020	7	1575	7PK1575
6	1432	6PK1432	6	2030	6PK2030	7	1593	7PK1593
6	1440	6PK1440	6	2040	6PK2040	7	1605	7PK1605
6	1450	6PK1450	6	2050	6PK2050	7	1637	7PK1637

For å se alle modeller eller andre strl., se hele vårt sortiment på [www.importex24.no](http://www.importex24.no)



## VIFTEREIMER



### Multireimer

### Kilereimer

Multireimer			Kilereimer					
Spor	Lengde (mm.)	Best.nr.	Spor	Lengde (mm.)	Best.nr.	Bredde	Lengde (mm.)	Best.nr.
7	1685	7PK1685	9	1920	9PK1920	10	650	10x650
7	1705	7PK1705	9	2835	9PK2835	10	675	10x675
7	1715	7PK1715	9	2871	9PK2871	10	700	10x700
7	1730	7PK1730	10	1070	10PK1070	10	725	10x725
7	1753	7PK1753	10	1108	10PK1108	10	750	10x750
7	1760	7PK1760	10	1136	10PK1136	10	775	10x775
7	1775	7PK1775	10	1145	10PK1145	10	800	10x800
7	1785	7PK1785	10	1980	10PK1980	10	825	10x825
7	1793	7PK1793	10	2020	10PK2020	10	850	10x850
7	1815	7PK1815	10	2070	10PK2070	10	875	10x875
7	1855	7PK1855	10	2220	10PK2220	10	900	10x900
7	1870	7PK1870	10	2335	10PK2335	10	925	10x925
7	1920	7PK1920	10	2475	10PK2475	10	950	10x950
7	1930	7PK1930	11	1890	11PK1890	10	975	10x975
7	1970	7PK1970	12	1815	12PK1815	10	1000	10x1000
7	1980	7PK1980	12	1830	12PK1830	10	1025	10x1025
7	2000	7PK2000	12	1835	12PK1835	10	1050	10x1050
7	2035	7PK2035				10	1075	10x1075
7	2060	7PK2060				10	1100	10x1100
7	2120	7PK2120				10	1125	10x1125
7	2265	7PK2265				10	1150	10x1150
7	2271	7PK2271				10	1175	10x1175
7	2315	7PK2315				10	1200	10x1200
7	2418	7PK2418				10	1225	10x1225
7	2535	7PK2535				10	1250	10x1250
7	2682	7PK2682				10	1275	10x1275
7	2842	7PK2842				10	1300	10x1300
7	2875	7PK2875				10	1325	10x1325
7	2958	7PK2958				10	1350	10x1350
6	1635	6PK1635				10	1375	10x1375
8	800	8PK800				10	1400	10x1400
8	835	8PK835				10	1425	10x1425
8	975	8PK975				10	1450	10x1450
8	1158	8PK1158				10	1475	10x1475
8	1173	8PK1173				10	1500	10x1500
8	1190	8PK1190				13	800	13x800
8	1225	8PK1225				13	825	13x825
8	1230	8PK1230				13	850	13x850
8	1255	8PK1255				13	875	13x875
8	1376	8PK1376				13	900	13x900
8	1400	8PK1400				13	925	13x925
8	1420	8PK1420				13	950	13x950
8	1438	8PK1438				13	1000	13x1000
8	1535	8PK1535				13	1025	13x1025
8	1655	8PK1655				13	1050	13x1050
8	1715	8PK1715				13	1075	13x1075
8	1795	8PK1795				13	1100	13x1100
8	1920	8PK1920						
8	1940	8PK1940						
8	1988	8PK1988						
8	2000	8PK2000						
8	2045	8PK2045						
8	2080	8PK2080						
8	2093	8PK2093						
8	2130	8PK2130						
8	2215	8PK2215						
8	2285	8PK2285						
8	2550	8PK2550						
8	2560	8PK2560						
8	2604	8PK2604						
9	1358	9PK1358						
9	1885	9PK1885						

For å se alle modeller eller andre strl., se hele vårt sortiment på [www.importex24.no](http://www.importex24.no)

## VOGN /- MOTORLISTE STOPPMAGNETER

<b>BOBCAT:</b>		
<b>Type:</b>	<b>Volt:</b>	<b>Best.nr.:</b>
316	12	8270-0784
319	12	8270-0784
322	12	8270-0784
323	12	8270-0784
324	12	8270-0784
325	12	8270-0967
328	12	8270-0967
329	12	8270-0967
330	12	8270-0784
331	12	8270-0967
334	12	8270-0967
335	12	8270-0967
337	12	8270-0967
341	12	8270-0967
418	12	8270-0784
430	12	8270-0967
435	12	8270-0967
453	12	8270-0784
E08	12	8270-0784
E10	12	8270-0784
E14	12	8270-0784
E16	12	8270-0784
E32	12	8270-0967
E35	12	8270-0967
E42	12	8270-0967
E45	12	8270-0967
E50	12	8270-0967
E55	12	8270-0967
S130	12	8270-0967
S150	12	8270-0967
S160	12	8270-0967
S175	12	8270-0967
S185	12	8270-0967
S205	12	8270-0967
S510	12	8270-0967
S530	12	8270-0967
S650	12	8270-0967
T110	12	8270-0967
T140	12	8270-0967
T180	12	8270-0967
T190	12	8270-0967
Div. med Kubota D722	12	8270-0784
Div. modeller	12	8270-0963
Div. modeller	12	8270-0967

<b>CASE / IH.:</b>		
<b>Type:</b>	<b>Volt:</b>	<b>Best.nr.:</b>
75XT	12	8270-0730
85XT	12	8270-0730
90XT	12	8270-0730
95XT	12	8270-0730
550G	12	8270-0730
570LXT	12	8270-0730
580L	12	8270-0730
580S	12	8270-0730
584E	12	8270-0730
585E	12	8270-0730
586E	12	8270-0730

For å se alle modeller eller andre strl., se hele vårt sortiment på [www.importex24.no](http://www.importex24.no)

## VOGN /- MOTORLISTE STOPPMAGNETER

CASE / IH.:		
Type:	Volt:	Best.nr.:
586E	24	8270-0742
588G	12	8270-0730
590S	12	8270-0730
650G	12	8270-0730
650G	24	8270-0742
660	12	8270-0730
686G	12	8270-0730
721	24	8270-0746
860	12	8270-0730
1150H	12	8270-0730
1840	12	8270-0730
1845C	12	8270-0730
8940	24	8270-0746*
MX100	12	8270-0730
MX110	12	8270-0730
MX120	12	8270-0730
MX135	12	8270-0730
MX150	12	8270-0730
MX170	12	8270-0730
Div. modeller	12	8270-0744

\* 8270-0741, 8270-0743 og 8270-0746 er like men har forskjellige støpsler. Se bilder.

Noen motorer kan være levert med forskjellige stoppmagneter, vennligst kontroller mot bilder.

Vi kan også levere til mange andre motorer. Vennligst forespør ut i fra motor data og org.nr.

CATERPILLAR:		
Type:	Volt:	Best.nr.:
235C	24	8270-0970
235D	24	8270-0970
245	24	8270-0970
246	12	8270-0777
3036	24	8270-0747
3064	12	8270-0969
3064	24	8270-0747
3066	12	8270-0969
3066	24	8270-0747
235C	24	8270-0970
235D	24	8270-0970
245D	24	8270-0970
3304B	24	8270-0970
3306	24	8270-0970
3306B	24	8270-0970
3406	24	8270-0970
3406C	24	8270-0970
375	24	8270-0970
375L	24	8270-0970
5080	24	8270-0970
621B	24	8270-0970
621E	24	8270-0970
621F	24	8270-0970
623B	24	8270-0970
623E	24	8270-0970
623F	24	8270-0970

**For å se alle modeller eller andre strl., se hele vårt sortiment på [www.importex24.no](http://www.importex24.no)**

## VOGN /- MOTORLISTE STOPPMAGNETER

<b>CATERPILLAR:</b>		
<b>Type:</b>	<b>Volt:</b>	<b>Best.nr.:</b>
627B	24	8270-0970
627E	24	8270-0970
627EPP	24	8270-0970
627F	24	8270-0970
814B	24	8270-0970
814F	24	8270-0970
815B	24	8270-0970
815F	24	8270-0970
816B	24	8270-0970
816F	24	8270-0970
824G	24	8270-0970
824GII	24	8270-0970
825G	24	8270-0970
826G	24	8270-0970
826GII	24	8270-0970
950B	24	8270-0970
950E	24	8270-0970
966E	24	8270-0970
966F	24	8270-0970
966FII	24	8270-0970
966G	24	8270-0970
972G	24	8270-0970
980C	24	8270-0970
980F	24	8270-0970
980FII	24	8270-0970
980G	24	8270-0970
980GII	24	8270-0970
D250E	24	8270-0970
D250EII	24	8270-0970
D300D	24	8270-0970
D300E	24	8270-0970
D350D	24	8270-0970
D350E	24	8270-0970
D400D	24	8270-0970
D400E	24	8270-0970
D40D	24	8270-0970
E70B	24	8270-0747
E200B	24	8270-0747
E320	24	8270-0747
m/div. Yanmar mot.	12	8270-0952
Div. motorer	12	8270-0966
Div. motorer	12	8270-0969
Div. motorer	24	8270-0970
<b>CUMMINS:</b>		
<b>Type:</b>	<b>Volt:</b>	<b>Best.nr.:</b>
4BT / 3,9L	12	8270-0730
4BT / 3,9L	24	8270-0734
4BT / 3,9L	24	8270-0736
4BT / 3,9L	24	8270-0742
6B / 5,9L	12	8270-0950*
6BT / 5,9L	12	8270-0730
6BT / 5,9L	12	8270-0731
6BT / 5,9L	24	8270-0736
6BT / 5,9L	24	8270-0742
6BT / 5,9L	24	8270-0746**
6BT / 5,9L	24	8270-0788
6C / 8,3L	12	8270-0950*

For å se alle modeller eller andre strl., se hele vårt sortiment på [www.importex24.no](http://www.importex24.no)

## VOGN /- MOTORLISTE STOPPMAGNETER

<b>CUMMINS:</b>		
Type:	Volt:	Best.nr.:
6CT / 8,3L	24	8270-0736
6CT / 8,3L	24	8270-0741**
6CT / 8,3L	24	8270-0743**
6CT / 8,3L	24	8270-0746**
Div. motorer	12	8270-0756
Div. motorer	12	8270-0950*
Div. motorer	12	8270-0954
Div. motorer	12	8270-0969
Div. motorer	24	8270-0731
Div. motorer	24	8270-0736
Div. motorer	24	8270-0747
Div. motorer	24	8270-0759
Div. motorer	24	8270-0790
Div. motorer	24	8270-0958

\* 8270-0744 OG 8270-0950 er like men har forskjellige støpsler. Se bilder.

\*\* 8270-0741, 8270-0743 og 8270-0746 er like men har forskjellige støpsler. Se bilder.

<b>DAEWOO:</b>		
Type:	Volt:	Best.nr.:
DH55	24	8270-0714
DH60	24	8270-0714
DH300-7 / -8	24	8270-0736

<b>DEUTZ:</b>		
Type:	Volt:	Best.nr.:
Div. motorer		Se KHD

<b>DETROIT:</b>		
Type:	Volt:	Best.nr.:
53	24	8270-0960
71	24	8270-0960
92	24	8270-0960
149	24	8270-0960
Div. motorer	24	8270-0960

<b>DODGE:</b>		
Type:	Volt:	Best.nr.:
m/Cummins 5,9L	12	8270-0708

Noen motorer kan være levert med forskjellige stoppmagneter, vennligst kontroller mot bilder.

Vi kan også levere til mange andre motorer. Vennligst forespør ut i fra motor data og org.nr.

<b>FIAT-HITACHI:</b>		
Type:	Volt:	Best.nr.:
EX200	12	8270-0955
ZX200	12	8270-0955
ZX230	12	8270-0955

<b>FORD:</b>		
Type:	Volt:	Best.nr.:
Div. motorer	12	8270-0791
Div. motorer	24	8270-0757

For å se alle modeller eller andre strl., se hele vårt sortiment på [www.importex24.no](http://www.importex24.no)



## VOGN /- MOTORLISTE STOPPMAGNETER

<b>GEHL:</b>		
Type:	Volt:	Best.nr.:
Div. motorer	12	8270-0963

<b>HANIX:</b>		
Type:	Volt:	Best.nr.:
Div. ISUZU motorer	24	8270-0719

<b>HITACHI</b>		
Type:	Volt:	Best.nr.:
Div. motorer	24	8270-0746*
Div. motorer	24	8270-0790

\* 8270-0741, 8270-0743 og 8270-0746 er like men har forskjellige støpsler. Se bilder.

<b>HYUNDAI:</b>		
Type:	Volt:	Best.nr.:
R55-5	12	8270-0733*
R55-7	12	8270-0752*
R60-5	12	8270-0733*
R60-7	12	8270-0752*
R80-7	24	8270-0714
R130	24	8270-0734
R140LC	24	8270-0734
R220-5	24	8270-0742
R290	24	8270-0746**
TB235	12	8270-0733*
Div. med Cummins	24	8270-0734
Div. med Cummins	24	8270-0742

\* 8270-0733, 8270-0752 og 8270-0774 er like men har forskjellige støpsler. Se bilder.

\*\* 8270-0741, 8270-0743 og 8270-0746 er like men har forskjellige støpsler. Se bilder.

<b>HYSTER:</b>		
Type:	Volt:	Best.nr.:
Div. motorer	12	8270-0777

<b>ISUZU:</b>		
Type:	Volt:	Best.nr.:
3KC1	12	8270-0955
4JG1	12	8270-0955
4JG1	24	8270-0719
4JG2	12	8270-0955
4JG2	24	8270-0719
6BB1	12	8270-0955
6BB1	24	8270-0719
6BG1	12	8270-0955
6BG1	24	8270-0719
Div. motorer	12	8270-0955
Div. motorer	24	8270-0719

Noen motorer kan være levert med forskjellige stoppmagneter, vennligst kontroller mot bilder.

Vi kan også levere til mange andre motorer. Vennligst forespør ut i fra motor data og org.nr.

<b>IHI:</b>		
Type:	Volt:	Best.nr.:
80NX	12	8270-0955

**For å se alle modeller eller andre strl., se hele vårt sortiment på [www.importex24.no](http://www.importex24.no)**

## VOGN /- MOTORLISTE STOPPMAGNETER

<b>JCB:</b>		
Type:	Volt:	Best.nr.:
8000	12	8270-0966
8008	12	8270-0966
8014	12	8270-0966
8016	12	8270-0966
FASTTRACK 3170	24	8270-0742
FASTTRACK 3185	24	8270-0742

<b>JOHN DEERE:</b>		
Type:	Volt:	Best.nr.:
4200	12	8270-0733*
4300	12	8270-0733*
4400	12	8270-0733*
4500	12	8270-0733*
4600	12	8270-0733*
4700	12	8270-0733*
Div. motorer	12	8270-0733*
Div. motorer	12	8270-0752*
m/ div. Yanmar	12	8270-0774*

\* 8270-0733, 8270-0752 og 8270-0774 er like men har forskjellige støpsler. Se bilder.

<b>KALMAR:</b>		
Type:	Volt:	Best.nr.:
DET 160-12 TRUCK 2002	24	8270-0721

<b>KATO:</b>		
Type:	Volt:	Best.nr.:
HD700-5	24	8270-0747
HD700-7	24	8270-0747

<b>KHD / DEUTZ:</b>		
Type:	Volt:	Best.nr.:
Agroprima 4.46	24	8270-0971
Agroprima 4.51	24	8270-0971
Agroprima 4.56	24	8270-0971
Agrostar 4.61	24	8270-0971
Agrostar 4.68	24	8270-0971
Agrostar 4.71	24	8270-0971
Agrostar 4.78	24	8270-0971
Agrotron 130	24	8270-0722
Agrotron 140	24	8270-0722
Agrotron 155	24	8270-0722
Agrotron 165	24	8270-0722
Agrotron 175, 175MK3	24	8270-0722
Agrotron 200, 200MK3	24	8270-0722
Agroxtra 4.47	24	8270-0971
Agroxtra 4.57	24	8270-0971
BF10L513	24	8270-0971
BF12L513	24	8270-0971
BF3L2011	12	8270-0965
BF4L913	24	8270-0971
BF4M1013	24	8270-0722
BF6M1013	24	8270-0722
BF6M1015	24	8270-0971
BF8L513	24	8270-0971
BF8M1015	24	8270-0971
BF913	24	8270-0971
BFL913	12	8270-0965

**For å se alle modeller eller andre strl., se hele vårt sortiment på [www.importex24.no](http://www.importex24.no)**

## VOGN /- MOTORLISTE STOPPMAGNETER

KHD / DEUTZ:		
Type:	Volt:	Best.nr.:
BFM1012E	24	8270-0757
BFM1012E	24	8270-0757
BFM1015	24	8270-0971
DX4.50	24	8270-0971
DX4.70	24	8270-0971
DX86	24	8270-0971
DX92	24	8270-0971
F3L1011	12	8270-0957
F3L2011	12	8270-0957
F3L912	24	8270-0971
F3M1011	12	8270-0957
F3M2011	12	8270-0957
F4L1011	12	8270-0957
F4L2011	12	8270-0957
F4L912	24	8270-0971
F4L913	24	8270-0971
F4M1011	12	8270-0957
F4M2011	12	8270-0957
FL413	24	8270-0971
FL513	24	8270-0971
FL912	12	8270-0965
FL912	24	8270-0971
FL913	12	8270-0965
FL913	24	8270-0971
m/ Cummins 6BT	24	8270-0731
Div. motorer	12	8270-0956
Div. motorer	12	8270-0957
Div. motorer	12	8270-0963
Div. motorer	12	8270-0965
Div. motorer	24	8270-0722
Div. motorer	24	8270-0731
Div. motorer	24	8270-0757
Div. motorer	24	8270-0971

KOBELCO:		
Type:	Volt:	Best.nr.:
Div. m/ Isuzu	12	8270-0955

KOMATSU:		
Type:	Volt:	Best.nr.:
HD700-5, -7	24	8270-0747
PC40	24	8270-0714
PC50	24	8270-0714
PC120-5	24	8270-0743**
PC210-6	24	8270-0743**
PC240-6	24	8270-0743**
PC240-6	24	8270-0742
PC290-6	24	8270-0743**
PC300-6	24	8270-0743**
PC300-7	24	8270-0741**
PC300-7	24	8270-0743**

\*8270-0733, 8270-0752 og 8270-0774 er like men har forskjellige støpsler. Se bilder.

\*\* 8270-0741, 8270-0743 og 8270-0746 er like men har forskjellige støpsler. Se bilder.

Noen motorer kan være levert med forskjellige stoppmagneter, vennligst kontroller mot bilder.

Vi kan også levere til mange andre motorer. Vennligst forespørr ut i fra motor data og org.nr.

**For å se alle modeller eller andre strl., se hele vårt sortiment på [www.importex24.no](http://www.importex24.no)**

## VOGN /- MOTORLISTE STOPPMAGNETER

KOMATSU:		
Type:	Volt:	Best.nr.:
PC300-7	24	8270-0746**
PC340	24	8270-0746**
PC350-7	24	8270-0741**
PC350-7	24	8270-0746**
PC360-7	24	8270-0741**
PC360-7	24	8270-0743**
PC360-7	24	8270-0746**
Div. motorer	12	8270-0752*
Div. motorer	24	8270-0742
Div. motorer	24	8270-0747

\*8270-0733, 8270-0752 og 8270-0774 er like men har forskjellige støpsler. Se bilder.

\*\* 8270-0741, 8270-0743 og 8270-0746 er like men har forskjellige støpsler. Se bilder.

Noen motorer kan være levert med forskjellige stoppmagneter, vennligst kontroller mot bilder.  
Vi kan også levere til mange andre motorer. Vennligst forespør ut i fra motor data og org.nr.

KUBOTA:		
Type:	Volt:	Best.nr.:
B1550	24	8270-0717
B7410	12	8270-0784
BX1500D	12	8270-0784
BX1800D	12	8270-0784
BX1830D	12	8270-0784
BX2200	24	8270-0717
BX2230D	12	8270-0784
D622	12	8270-0784
D622	12	8270-0775
D722	12	8270-0784
D722	12	8270-0775
D782	12	8270-0784
D782	12	8270-0775
D902	12	8270-0784
D902	12	8270-0775
D905	12	8270-0962
D905	24	8270-0717
D950	12	8270-0775
D1005	12	8270-0962
D1005	24	8270-0717
D1105	12	8270-0962
D10105	24	8270-0717
F2000	24	8270-0717
G1700	12	8270-0784
G1800, S	12	8270-0784
G1900, S	12	8270-0784
G2160, DS	12	8270-0784
GF1800, E	12	8270-0784
GL900	12	8270-0784
K008	12	8270-0784
KX36	12	8270-0784
KX101	24	8270-0717
KX151	24	8270-0717
KX161	24	8270-0717
L2550	24	8270-0717

\* 8270-0733, 8270-0752 og 8270-0774 er like men har forskjellige støpsler. Se bilder.

\*\* 8270-0744 OG 8270-0950 er like men har forskjellige støpsler. Se bilder.

**For å se alle modeller eller andre strl., se hele vårt sortiment på [www.importex24.no](http://www.importex24.no)**

## VOGN /- MOTORLISTE STOPPMAGNETER

<b>KUBOTA:</b>		
Type:	Volt:	Best.nr.:
RTV900R, S, T, W	12	8270-0784
T1600H, HG	12	8270-0784
TG1860	12	8270-0784
V1205	12	8270-0962
V1205	24	8270-0717
V1305	12	8270-0962
V1305	24	8270-0717
V1505, T	12	8270-0962
V1505, T	24	8270-0717
V2003	12	8270-0967
V2203	12	8270-0967
V2203	24	8270-0717
Z402	12	8270-0784
Z482	12	8270-0784
Z482	12	8270-0959
Z602	12	8270-0784
Z682	12	8270-0784
ZD18F	12	8270-0784
ZD21F	12	8270-0784
Div. motorer	12	8270-0744**
Div. motorer	12	8270-0775
Div. motorer	12	8270-0962
Div. motorer	12	8270-0968
Div. motorer	24	8270-0717
m/ div. Cummins	12	8270-0950
m/ div. Cummins	24	8270-0958
m/ div. Yanmar	12	8270-0733*
m/ div. Yanmar	12	8270-0774*

\* 8270-0733, 8270-0752 og 8270-0774 er like men har forskjellige støpsler. Se bilder.

\*\* 8270-0744 OG 8270-0950 er like men har forskjellige støpsler. Se bilder.

<b>LISTER:</b>		
Type:	Volt:	Best.nr.:
Div. motorer	12	8270-0791
Div. motorer	24	8270-0757

Noen motorer kan være levert med forskjellige stoppmagneter, vennligst kontroller mot bilder.

Vi kan også levere til mange andre motorer. Vennligst forespør ut i fra motor data og org.nr.

<b>MERCUISER:</b>		
Type:	Volt:	Best.nr.:
3,9L	12	8270-0730
3,9L	24	8270-0742

<b>MITSUBISHI:</b>		
Type:	Volt:	Best.nr.:
6D14	24	8270-0747
6D31	24	8270-0747
K3B-31DS	12	8270-0951
K3E-31NSA	12	8270-0951
K3E-61ES	12	8270-0951
K4D-61KL	12	8270-0951
K4E-61ES, WH	12	8270-0951
K4E-D31NSA	12	8270-0951
K4F-E1T	12	8270-0951
K4N-D31NSA	12	8270-0951
K4N-D361ES	12	8270-0951

For å se alle modeller eller andre strl., se hele vårt sortiment på [www.importex24.no](http://www.importex24.no)



## VOGN /- MOTORLISTE STOPPMAGNETER

<b>mitsubishi:</b>		
Type:	Volt:	Best.nr.:
K4N-EID	12	8270-0951
K4N-ELD	12	8270-0951
S3L-2-61NS	12	8270-0951
S3L2Y1	12	8270-0951
S4L, S4L2	12	8270-0951
S6K	24	8270-0747
SL	12	8270-0961
Div. motorer	12	8270-0961

<b>MUSTANG:</b>		
Type:	Volt:	Best.nr.:
2040	24	8270-0714

<b>MWM:</b>		
Type:	Volt:	Best.nr.:
D226	12	8270-0966

<b>NANNI:</b>		
Type:	Volt:	Best.nr.:
4.220HE	12	8270-0959

<b>PERKINS:</b>		
Type:	Volt:	Best.nr.:
402-Serie	12	8270-0966
403-Serie	12	8270-0966
404-Serie	12	8270-0966
700-Serie	12	8270-0777
1000-Serie fra 127Hk.	12	8270-0756
2306-Serie	12	8270-0966
4.165	12	8270-0791
6.354	12	8270-0791
6.354	24	8270-0757
Div. motorer	12	8270-0718
Div. motorer	12	8270-0777
Div. motorer	12	8270-0791
Div. motorer	12	8270-0966
Div. motorer	24	8270-0729
Div. motorer	24	8270-0731
Div. motorer	24	8270-0757

<b>ROBEX:</b>		
Type:	Volt:	Best.nr.:
70-8	24	8270-0714

<b>SABB - MITSUBISHI:</b>		
Type:	Volt:	Best.nr.:
Div. motorer	12	8270-0951

<b>SCANIA:</b>		
Type:	Volt:	Best.nr.:
3-Serie	12	8270-0953
Div. motorer	24	8270-0964

For å se alle modeller eller andre strl., se hele vårt sortiment på [www.importex24.no](http://www.importex24.no)

## VOGN /- MOTORLISTE STOPPMAGNETER

<b>SOLE DIESEL:</b>		
Type:	Volt:	Best.nr.:
Mini-14	12	8270-0951
Mini-23	12	8270-0951
Mini-33	12	8270-0951
Mini-34	12	8270-0951
Mini-44	12	8270-0951

<b>TAKEUCHI:</b>		
Type:	Volt:	Best.nr.:
Div. motorer	12	8270-0752*

\* 8270-0733, 8270-0752 og 8270-0774 er like men har forskjellige støpsler. Se bilder.

Noen motorer kan være levert med forskjellige stoppmagneter, vennligst kontroller mot bilder.  
Vi kan også levere til mange andre motorer. Vennligst forespør ut i fra motor data og org.nr.

<b>THERMO KING:</b>		
Type:	Volt:	Best.nr.:
m/Yanmar se Yanmar	12	8270-0774*

<b>VOLVO PENTA:</b>		
Type:	Volt:	Best.nr.:
2001, 2002, 2003	12	8270-0953
AQ70B, C, D	12	8270-0953
AQ115, B	24	8270-0727
AQ130, A, B, C, D	24	8270-0727
AQ165A	24	8270-0727
AQ170A, B, C	24	8270-0727
AQD21A	24	8270-0727
AQD70B, D, BL, CL	24	8270-0727
D42A	12	8270-0953
D100A,B	12	8270-0953
D120A	12	8270-0953
EC13	12	8270-0711
EC15, B	12	8270-0711
EC20, B	12	8270-0711
EC25	12	8270-0711
EC30	12	8270-0711
EC35	12	8270-0711
EC45	12	8270-0711
EC140	24	8270-0742
L70C, L70D	24	8270-0776
L90B	24	8270-0785
L90C, L90D	24	8270-0776
L90C	24	8270-0785
L120B	24	8270-0785
L120C, L120D	24	8270-0776
L150C, L150D	24	8270-0776
L180B	24	8270-0785
L180C, L180D	24	8270-0776
L220D	24	8270-0776
L330C, L330D	24	8270-0776
MD70B, C	12	8270-0953
MD70B, C	24	8270-0727
MD100A, B	12	8270-0953

Noen motorer kan være levert med forskjellige stoppmagneter, vennligst kontroller mot bilder.  
Vi kan også levere til mange andre motorer. Vennligst forespør ut i fra motor data og org.nr.

**For å se alle modeller eller andre strl., se hele vårt sortiment på [www.importex24.no](http://www.importex24.no)**

## VOGN /- MOTORLISTE STOPPMAGNETER

VOLVO PENTA:		
Type:	Volt:	Best.nr.:
MD100A, B	24	8270-0727
MD120A, B	12	8270-0953
MD120A	24	8270-0727
TAD720	24	8270-0721
TAD1230G	24	8270-0727
TAD1231GE	24	8270-0727
TAD1232GE	24	8270-0727
TAMD60, A, B, C	12	8270-0953
TAMD61A	12	8270-0953
TAMD61A	24	8270-0727
TAMD62A	12	8270-0953
TAMD62A	24	8270-0727
TAMD70B, C, D, E	12	8270-0953
TAMD70B, C, D, E	24	8270-0727
TAMD71A, B	12	8270-0953
TAMD71A, B	24	8270-0727
TAMD72A, P	12	8270-0953
TAMD72A	24	8270-0727
TAMD73, P	12	8270-0953
TAMD73	24	8270-0727
TAMD74	12	8270-0953
TAMD75	12	8270-0953
TAMD100	24	8270-0727
TAMD102A, D	24	8270-0727
TAMD103A	24	8270-0727
TAMD120A, B	12	8270-0953
TAMD121C, D	24	8270-0727
TAMD122A, C, D, P	24	8270-0727
TAMD123	24	8270-0727
TAMD162C	12	8270-0953
TAMD162A, B, C	24	8270-0727
TAMD163A, P	12	8270-0953
TAMD163A, P	24	8270-0727
TAMD165A, C, P	24	8270-0727
TD30	24	8270-0727
TD31	24	8270-0727
TD40	24	8270-0727
TD45	24	8270-0727
TD60A, B	24	8270-0727
TD61, A	12	8270-0953
TD61, A	24	8270-0727
TD70B, G	24	8270-0727
TD71, A	12	8270-0953
TD71, A	24	8270-0727
TD100A	12	8270-0953
TD100	24	8270-0727
TD120A, G	12	8270-0953
TD120A, C	24	8270-0727
TD121	24	8270-0727
TD1210G	24	8270-0727
TD610M, V	12	8270-0953
TD630ME	12	8270-0953
TD730ME	12	8270-0953
THAMD70, B, C	12	8270-0953
THAMD70, B, C	24	8270-0727

Noen motorer kan være levert med forskjellige stoppmagneter, vennligst kontroller mot bilder.  
Vi kan også levere til mange andre motorer. Vennligst forespør ut i fra motor data og org.nr.

**For å se alle modeller eller andre strl., se hele vårt sortiment på [www.importex24.no](http://www.importex24.no)**

## VOGN /- MOTORLISTE STOPPMAGNETER

VOLVO PENTA:		
Type:	Volt:	Best.nr.:
TMD70, B, C	12	8270-0953
TMD70, B, C	24	8270-0727
TMD100A, B	12	8270-0953
TMD100, C	24	8270-0727
TMD102A	24	8270-0727
TMD120A, B	12	8270-0953
TMD121C	24	8270-0727
TMD122A, C	24	8270-0727
TMD120	12	8270-0953
TWD1210G	24	8270-0727
TWD1211G	24	8270-0727
TWD1630VE	12	8270-0953
TWD1630VE	24	8270-0727
Div. motorer	12	8270-0953
Div. motorer	24	8270-0734
Div. motorer	24	8270-0776
Div. motorer	24	8270-0785
Div. motorer	24	8270-0960

Noen motorer kan være levert med forskjellige stoppmagneter, vennligst kontroller mot bilder.  
Vi kan også levere til mange andre motorer. Vennligst forespørr ut i fra motor data og org.nr.

YANMAR:		
Type:	Volt:	Best.nr.:
2TNV70	12	8270-0733**
3JH2 / -E / -TE	12	8270-0952
3JH3 / -E / -YEU	12	8270-0952
3TNE68	12	8270-0733**
3TNE84	12	8270-0774**
3TNE88	12	8270-0774**
3TNV70	12	8270-0774**
3TNV76	12	8270-0733**
3TNV76	12	8270-0774**
3TNV76	24	8270-0714
3TNV88	12	8270-0733**
4JH / -E / -TE / -HTE	12	8270-0952
4JH2 / -E / -TE / -DET	12	8270-0952
4JH2-HTE	12	8270-0952
4JH3	12	8270-0952
4JH3-TE / -DTE / -HTE	12	119171-67200*
4JH3E-YEU	12	8270-0952
4LH-DTE / -STE	12	8270-0952
4LHA / -DTE / -DTZE	12	8270-0952
4LHA-DTP / -DTZP	12	8270-0952
4LHA-HTE / -HTZE	12	8270-0952
4LHA-STE / -STZE	12	8270-0952
4LHA-STP / -STZP	12	8270-0952
4TNE84	12	8270-0752**
4TNE84	12	8270-0774**
4TNE88	12	8270-0752**
4TNE98	12	8270-0752**

\* Org.nr. / Kan foreløpig ikke leveres.

\*\* 8270-0733, 8270-0752 og 8270-0774 er like men har forskjellige støpsler. Se bilder.

\*\*\* 8270-0744 OG 8270-0950 er like men har forskjellige støpsler. Se bilder.

Noen motorer kan være levert med forskjellige stoppmagneter, vennligst kontroller mot bilder.  
Vi kan også levere til mange andre motorer. Vennligst forespørr ut i fra motor data og org.nr.

**For å se alle modeller eller andre strl., se hele vårt sortiment på [www.importex24.no](http://www.importex24.no)**

## VOGN /- MOTORLISTE STOPPMAGNETER

YANMAR:		
Type:	Volt:	Best.nr.:
4TNE100	12	8270-0752**
4TNV84T	12	8270-0774**
4TNV88	12	8270-0733**
4TNV88	12	8270-0774**
4TNV94L	12	8270-0752**
4TNV94L	12	8270-0774**
4TNV98L	12	8270-0752**
4TNV98L	12	8270-0774**
4TNV98	24	8270-0714
4TNV106	12	8270-0752**
4TNV106	12	8270-0774**
6CX	12	8270-0952
6LP	12	8270-0952
6LP-DTE / -DTZE	12	119773-51980*
6LP-DTP / -DTZP	12	119773-51980*
6LP-STE / -STZE	12	119773-51980*
6LP-STP / -STZP	12	119773-51980*
6LY / -STE / -UTE	12	8270-0952
6LYA-STE / -UTE	12	8270-0952
6LYM-STE / -UTE	12	8270-0952
6LY2-STE	12	8270-0952
6LY2A-STP	12	8270-0952
Div. motorer	12	8270-0774**
Div. motorer	12	8270-0791
Div. motorer	12	8270-0950***
Div. motorer	24	8270-0757
Div. motorer	24	8270-0714
Div. motorer	24	8270-0958

\* Org.nr. / Kan foreløpig ikke leveres.

\*\* 8270-0733, 8270-0752 og 8270-0774 er like men har forskjellige støpsler. Se bilder.

\*\*\* 8270-0744 OG 8270-0950 er like men har forskjellige støpsler. Se bilder.

**Noen motorer kan være levert med forskjellige stoppmagneter, vennligst kontroller mot bilder.**

**Vi lever til mange andre motorer, vennligst forespør ut i fra motor data og org.nr.**

**For å se alle modeller eller andre strl., se hele vårt sortiment på [www.importex24.no](http://www.importex24.no)**



## STOPPMAGNETER

STOPPMAGNETER		
Best.nr	Tekn. data	
<b>8270-0708</b>	<p style="text-align: center;"><b>12 Volt</b></p> <p><b>Passer på:</b> Cummins 5,9L Dodge med 5,9L Cummins (94-98)</p> <p><b>Erstatter:</b> Cummins: 3800723, 3923201, 3931570 Mopar: 5016244, 5016244AA Synchrostart/Woodward: SA-4981-12 Holdwell: HD04400176</p> <p><b>8270-0744 og 8270-0950 er lik men har annet støpsel</b></p>	
<b>8270-0711</b>	<p style="text-align: center;"><b>12 Volt</b></p> <p><b>Passer på:</b> Mitsubishi Volvo EC13,15, 15B, 20, 20B, 25, 30, 35, 45</p> <p><b>Erstatter:</b> Mitsubishi: 30A87-00040, 30A87-10044, 30A87-20404, PJ7415748 Volvo: 7415748 Synchrostart/Woodward: SA-3725-12, 1751ES</p>	
<b>8270-0714</b>	<p style="text-align: center;"><b>24 Volt</b></p> <p><b>Passer på:</b> Daewoo, Hyundai, John Deere, Komatsu, Yanmar</p> <p><b>Erstatter:</b> Holdwell: HD04400100 Yanmar: 119233-77932, 119612-77940 Synchrostart/Woodward: 1503ES-24S5SUC12S</p> <p><b>Tilsvarende i 12 volt er 8270-0733.</b></p>	
<b>8270-0716</b>	<p style="text-align: center;"><b>12 Volt</b></p> <p><b>Passer på:</b> Cummins</p> <p><b>Erstatter:</b> Cummins: 3934174</p> <p><b>Tilsvarende i 24 volt er 8270-0746.</b></p>	





For å se alle modeller eller andre strl., se hele vårt sortiment på [www.importex24.no](http://www.importex24.no)

## STOPPMAGNETER

STOPPMAGNETER		
Best.nr	Tekn. data	
<b>8270-0717</b>	<p style="text-align: center;"><b>24 Volt</b></p> <p><b>Passer på:</b> Kubota</p> <p><b>Erstatter:</b> Kubota: 90402 Synchrostart/Woodward: SA-4567, 1503ES24A5UC5S</p> <p><b>Tilsvarende i 12 volt er 8270-0775.</b></p>	
<b>8270-0718</b>	<p style="text-align: center;"><b>12 Volt    Trekk: 25A / Hold: 0,6A</b></p> <p><b>Passer på:</b> Perkins</p> <p><b>Erstatter:</b> CAV: 1827-650, 263A25 Akel: 4035 Holdwell: HD04100535</p> <p><b>Tilsvarende i 24 volt er 8270-0729.</b></p>	 <p style="text-align: center;"><b>Lik denne med 3 ledninger er 8270-0953</b></p>
<b>8270-0718P</b>	<p style="text-align: center;"><b>12 Volt    Trekk: 26,6A / Hold: 1,3A</b></p> <p><b>Samme som over men original CAV / Prestolite.</b></p> <p>Leveres uten retur fjær.</p> <p><b>Tilsvarende i 24 volt er 8270-0729P.</b></p>	
<b>8270-0719</b>	<p style="text-align: center;"><b>24Volt</b></p> <p><b>Passer på:</b> Isuzu, Aichi m/Isuzu, Hanix m/ Isuzu</p> <p><b>Erstatter:</b> Isuzu: 1-81910-0520, X-81810-0520 Synchrostart/Woodward: MV2-17A</p> <p><b>Tilsvarende i 12 volt er 8270-0955.</b></p>	

**For å se alle modeller eller andre strl., se hele vårt sortiment på [www.importex24.no](http://www.importex24.no)**

## STOPPMAGNETER

STOPPMAGNETER		
Best.nr	Tekn. data	
<b>8270-0721</b>	<p style="text-align: center;"><b>24Volt</b></p> <p><b>Passer på:</b> Deutz Kalmar Truck DTE160-12 Ca. 2002 KHD Volvo</p> <p><b>Erstatter:</b> Deutz: 02113793, 04199905</p>	
<b>8270-0722</b>	<p style="text-align: center;"><b>24Volt</b></p> <p><b>Passer på:</b> Deutz</p> <p><b>Erstatter:</b> Deutz: 04199903, 04206916, A063301102 Holdwell: HD04400144</p>	
<b>8270-0724</b>	<p style="text-align: center;"><b>24Volt</b></p> <p><b>Passer på:</b> Kubota</p> <p><b>Erstatter:</b> Kubota: 17208-60010, 17208-60011, 17208-60012 17208-60013, 17208-60014, 17208-60015, 17208-60016, 17208-60017</p>	
<b>8270-0727</b>	<p style="text-align: center;"><b>24 Volt Trekk: 27A / Hold: 0,5A</b></p> <p><b>Passer på:</b> Volvo-Penta</p> <p><b>Erstatter:</b> Volvo-Penta: 3826742, 52318, 872805, 872825, 873718, 873754, 876276, 876593, 876789, 876836, 881532, 881969, 888468, 1830592, 81151144 81150237 Akel: 4020 Holdwell: HD04100535, HWS0148</p> <p><b>Tilsvarende i 12 volt er 8270-0953.</b></p>	 <p style="font-size: small;">Sort ledning: Jord Hvit ledning: Kobles mot starters styrestrøm. Rød ledning: Kobles mot pluss over tenning.</p>

For å se alle modeller eller andre strl., se hele vårt sortiment på [www.importex24.no](http://www.importex24.no)

## STOPPMAGNETER

STOPPMAGNETER		
Best.nr	Tekn. data	
<b>8270-0729</b>	<p style="text-align: center;"><b>24 Volt    Trekk: 27A / Hold: 0,5A</b></p> <p><b>Passer på:</b> Perkins</p> <p><b>Erstatter:</b> CAV: 1827-631, 263A23 Perkins: 51557, 52318 Akel: 4030 Holdwell: HD04400073</p> <p><b>Tilsvarende i 12 volt er 8270-0718.</b></p>	 <p style="text-align: center;"><b>Lik denne med 3 ledninger er 8270-0727</b></p>
<b>8270-0729P</b>	<p style="text-align: center;"><b>24 Volt    Trekk: 18,5A / Hold: 0,62A</b></p> <p><b>Samme som over men original CAV/Prestolite</b></p> <p>Leveres uten retur fjær.</p> <p><b>Tilsvarende i 12 volt er 8270-0718P.</b></p>	
<b>8270-0730</b>	<p style="text-align: center;"><b>12 Volt</b></p> <p><b>Passer på:</b> Case, Cummins, Mercruiser</p> <p><b>Erstatter:</b> Case: J930658, J932529 Cummins: 3930658, 3932529, 3939700 Synchrostart/Woodward: SA-4756-12, SA-4891-12 Akel: 1045 Holdwell: HD46646247, HWS0334</p> <p><b>Tilsvarende i 24 volt er 8270-0742.</b></p>	
<b>8270-0731</b>	<p style="text-align: center;"><b>24 Volt</b></p> <p><b>Passer på:</b> Cummins, Deutz, KHD, Perkins Bosch RSV</p> <p><b>Erstatter:</b> Synchrostart/Woodward: SA-3765-24, 1751-24.... Akel: 2060 Holdwell: HD04100604</p> <p><b>Tilsvarende i 12 volt er 8270-0956.</b></p>	

**For å se alle modeller eller andre strl., se hele vårt sortiment på [www.importex24.no](http://www.importex24.no)**





## STOPPMAGNETER

STOPPMAGNETER		
Best.nr	Tekn. data	
<b>8270-0733</b>	<p style="text-align: center;"><b>12 Volt</b></p> <p><b>Passer på:</b> John Deere, Hyundai, Kubota, Yanmar</p> <p><b>Erstatter:</b> Yanmar: 119233-66510, 119233-77931, 119233-77932, 1249407-1500 John Deere: M810324 Synchrostart/Woodward: 1503ES-12S5SUC12S Akel: 1175 Holdwell: HD46646250</p> <p style="text-align: center;"><b>8270-0752 og 8270-0774 er lik men har annet støpsel. Tilsvarende i 24 volt er 8270-0714.</b></p>	
<b>8270-0734</b>	<p style="text-align: center;"><b>24 Volt</b></p> <p><b>Passer på:</b> Cummins, Hyundai m/Cummins, Volvo</p> <p><b>Erstatter:</b> Cummins: 3964628, 3991168 Synchrostart/Woodward: SA-4941 Akel: 1210 Holdwell: HD04100511</p>	
<b>8270-0736</b>	<p style="text-align: center;"><b>24 Volt</b></p> <p><b>Passer på:</b> Cummins, Daewoo</p> <p><b>Erstatter:</b> Cummins: 3935650 VW: 2TO201114A Synchrostart/Woodward: SA-4764 Holdwell: HWS0232</p>	
<b>8270-0741</b>	<p style="text-align: center;"><b>24 Volt</b></p> <p><b>Passer på:</b> Cummins, Komatsu</p> <p><b>Erstatter:</b> Komatsu: 6743-81-9141</p> <p style="text-align: center;"><b>8270-0743 er 8270-0746 er lik men har annet støpsel.</b></p>	

For å se alle modeller eller andre strl., se hele vårt sortiment på [www.importex24.no](http://www.importex24.no)





## STOPPMAGNETER

STOPPMAGNETER		
Best.nr	Tekn. data	
<b>8270-0742</b>	<p style="text-align: center;"><b>24 Volt</b></p> <p><b>Passer på:</b> Case, Cummins, Hyundai, JCB, Komatsu, Mercruiser</p> <p><b>Erstatter:</b> Cummins: 3931590, 3932530, 3935430, 3939701 Komatsu: 6377-81-9110, 6377-81-9130 Syncrostart/Woodward: SA-4756-24, SA-4891-24 Akel: 1040 Holdwell: HD04100516, HWS0255</p> <p><b>Tilsvarende i 12 volt er 8270-0730.</b></p>	
<b>8270-0743</b>	<p style="text-align: center;"><b>24 Volt</b></p> <p><b>Passer på:</b> Cummins, Komatsu</p> <p><b>Erstatter:</b> Cummins: 4063712 Komatsu: 600-815-9150, 6742-01-2310, Synchrostart/Woodward: SA-5030, 1755ES.....</p> <p style="text-align: center;"><b>8270-0741 og 8270-0746 er lik men har annet støpsel.</b></p>	
<b>8270-0744</b>	<p style="text-align: center;"><b>12 Volt Trekk: 46A / Hold: 1,1A</b></p> <p><b>Passer på:</b> Case - IH, Cummins 5,9L, Dodge, Kubota</p> <p><b>Erstatter:</b> Cummins: 3800723, 3923201, 3931570 Mopar: 5016244 Synchrostart/Woodward: SA-4673, SA-4981-12, 1571ES12A3UC12B1S, 1700-4005 Akel: 1025 Holdwell: HD04400176, HWS0233, HWS0352</p> <p style="text-align: center;"><b>8270-0950 er lik men har annet støpsel.</b></p>	
<b>8270-0746</b>	<p style="text-align: center;"><b>24 Volt</b></p> <p><b>Passer på:</b> Case, Cummins, Hitachi, Hyundai, Komatsu</p> <p><b>Erstatter:</b> Cummins: 3928161, 3930234, 3964624 Komatsu: 6740-01-2310, 6743-81-9140, 6743-81-9141 Synchrostart/Woodward: SA-4335, SA-5030 Akel: 1010 Holdwell: HD04100547, HWS0002</p> <p style="text-align: center;"><b>8270-0741 og 8270-0743 er lik men har annet støpsel.</b></p> <p><b>Tilsvarende i 12 volt er 8271-0716.</b></p>	

**For å se alle modeller eller andre strl., se hele vårt sortiment på [www.importex24.no](http://www.importex24.no)**



## STOPPMAGNETER

STOPPMAGNETER		
Best.nr	Tekn. data	
<b>8270-0747</b>	<p style="text-align: center;"><b>24 Volt</b></p> <p><b>Passer på:</b> Cummins, Caterpillar, Kato, Komatsu, Mitsubishi</p> <p><b>Erstatter:</b> Cummins: 3864274 Komatsu: SPA90902NI Synchrostart/Woodward: SA-3933, 1700-2536, 1751ES24E7U1B1S5A, 74933221736 Akel: 2070-3</p> <p><b>Tilsvarende i 12 volt er 8270-0969.</b></p>	
<b>8270-0752</b>	<p style="text-align: center;"><b>12 Volt</b></p> <p><b>Passer på:</b> John Deere, Komatsu, Takeuchi, Yanmar</p> <p><b>Erstatter:</b> Yanmar: 119053-77950, 119285-77950, 119653-77950, 20111123 Synchrostart/Woodward: SA-4562T, SA-5213, 1503ES12S5SUC5S. Holdwell: HD46647380</p> <p><b>8270-0733 og 8270-0774 er lik men har annet støpsel.</b></p>	
<b>8270-0756</b>	<p style="text-align: center;"><b>12 Volt    Trekk: 25A / Hold: 0,9A</b></p> <p><b>Passer på:</b> Cummins, Perkins</p> <p><b>Erstatter:</b> Synchrostart/Woodward: 2001-12E2U1B2S1A, 2001-12E2U1B2S2A, 2000-4518, 2003ES-12V Akel: 2035-3 Holdwell: HD45018907</p> <p><b>Tilsvarende i 24 volt er 8270-0759.</b></p>	 <p style="text-align: center;">AUX er et + uttak, dette trenger IKKE å være tilkoblet.</p>
<b>8270-0757</b>	<p style="text-align: center;"><b>24Volt    Trekk: 16A / Hold: 0,7A</b></p> <p><b>Passer på :</b> Ford, Lister, Perkins, Yanmar</p> <p><b>Erstatter:</b> Lister: 362366 Perkins: 2848238 Synchrostart/Woodward: SA-2945, SA-3453, 1500-2051, de fleste 1502-24V og 1504-24V Akel: 3000 Holdwell: HD46647048</p> <p><b>Tilsvarende 12 volt er 8270-0791.</b></p>	 <p style="text-align: center;">AUX er et + uttak, dette trenger IKKE å være tilkoblet.</p>

**For å se alle modeller eller andre strl., se hele vårt sortiment på [www.importex24.no](http://www.importex24.no)**

## STOPPMAGNETER

STOPPMAGNETER		
Best.nr	Tekn. data	
<b>8270-0759</b>	<p style="text-align: center;"><b>24 Volt    Trekk: 28A / Hold: 0,8A</b></p> <p><b>Passer på:</b> Cummins</p> <p><b>Erstatter:</b> Synchrostart/Woodward: SA-3091, SA-3194, SA-3329, 2000-4523, 2001-24E3U1B2S1A, 2003-24E3U1B1A, 2003ES-24 Akel: 2030-3 Holdwell: HD04400164</p> <p><b>Tilsvarende 12 volt er 8270-0756.</b></p>	 <p>AUX er et + uttak, dette trenger IKKE å være tilkoblet.</p>
<b>8270-0774</b>	<p style="text-align: center;"><b>12 Volt</b></p> <p><b>Passer på:</b> John Deere, Kubota, Thermoking, Yanmar</p> <p><b>Erstatter:</b> Yanmar: 119233-77930, 119233-77931, 119233-77932, 129486-77952, 129486-77953, 129486-77954, 129486-77983 Synchrostart/Woodward: SA-4564, SA-4817, SA-4920, 1503ES12S5SUC11S. Akel: 1175 Holdwell: HD04400097</p> <p><b>8270-0733 og 8270-0752 er lik men har annet støpsel.</b></p>	
<b>8270-0775</b>	<p style="text-align: center;"><b>12 Volt</b></p> <p><b>Passer på:</b> Kubota</p> <p><b>Erstatter:</b> Kubota: 16616-60010, 16616-60013, 16616-60015 17454-60010, 17594-60014 Synchrostart/Woodward: SA-4569T, 1503ES12A5UC5S</p> <p><b>Tilsvarende 24 volt er 8270-0717.</b></p>	
<b>8270-0776</b>	<p style="text-align: center;"><b>24 Volt</b></p> <p><b>Passer på:</b> Volvo</p> <p><b>Erstatter:</b> Volvo: 090267, 11110030 Synchrostart/Woodward: SA-44646-24, SA-4744-24 Holdwell: HD46645276, HWS33700</p>	 <p>Ø 6mm      38mm</p>

For å se alle modeller eller andre strl., se hele vårt sortiment på [www.importex24.no](http://www.importex24.no)

## STOPPMAGNETER

STOPPMAGNETER		
Best.nr	Tekn. data	
<b>8270-0777</b>	<p style="text-align: center;"><b>12 Volt</b></p> <p><b>Passer på:</b> Caterpillar, Hyster, Perkins</p> <p><b>Erstatter:</b> Perkins: 2848A275 Synchrostart/Woodward: SA-4934 Akel: 1185 Holdwell: HWS0310, HD04400109</p>	
<b>8270-0784</b>	<p style="text-align: center;"><b>12 Volt</b></p> <p><b>Passer på:</b> Kubota</p> <p><b>Erstatter:</b> Dendo: 052600-4530, 052600-4531 Kubota: 16851-60011, 16851-60014 Holdwell: HW04405020</p>	
<b>8270-0785</b>	<p style="text-align: center;"><b>24 Volt</b></p> <p><b>Passer på:</b> Volvo</p> <p><b>Erstatter:</b> Volvo: 7750989, 11033954 Synchrostart/Woodward: SA-4527, 1756ESDB Holdwell: HD46647496</p>	
<b>8270-0788</b>	<p style="text-align: center;"><b>24 Volt</b></p> <p><b>Passer på:</b> Cummins, Deutz, Bosch RSV</p> <p><b>Erstatter:</b> Cummins: 3900107, 4942879, 5254169 Synchrostart/Woodward: SA-3742-24V</p> <p><b>Tilsvarende 12 volt er 8270-0972.</b></p>	

For å se alle modeller eller andre strl., se hele vårt sortiment på [www.importex24.no](http://www.importex24.no)

## STOPPMAGNETER

STOPPMAGNETER		
Best.nr	Tekn. data	
<b>8270-0790</b>	<p style="text-align: center;"><b>24 Volt</b></p> <p><b>Passer på:</b> Cummins</p> <p><b>Erstatter:</b> Cummins: 3185857, 3919423 Synchrostart/Woodward: SA-4780, 1751ES24A7UC9B5S5 Akel: 1020 Holdwell: HW04100189</p> <p style="text-align: center;"><b>8270-0958 er lik men har annet støpsel.</b></p>	
<b>8270-0791</b>	<p style="text-align: center;"><b>12 Volt Trekk: 19A / Hold: 1A</b></p> <p><b>Passer på:</b> Ford, Lister, Perkins, Yanmar</p> <p><b>Erstatter:</b> Lister: 201-39410, 366-06845, 601-41430, 362667 Perkins: 2848A231 Synchrostart/Woodward: De fleste 1502-12V 1500-2005, 1500-2040, 1500-2107, SA-2944, SA-3134, SA-3452, SA-3455 Akel: 3005 Holdwell: HD46646482, HWS0280</p> <p><b>Tilsvarende i 24 volt er 8270-0757.</b></p>	 <p style="text-align: center;">AUX er et + uttak, dette trenger IKKE å være tilkoblet.</p>
<b>8270-0950</b>	<p style="text-align: center;"><b>12 Volt</b></p> <p><b>Passer på:</b> Cummins, Kubota, Yanmar</p> <p><b>Erstatter:</b> Cummins: 3832211, 3919422, 3927152, 3934171 Yanmar: 129953-77810 Synchrostart/Woodward: SA-3665, SA-4754, 1753ES-12A6UC3B1S1 Holdwell: HWS0072</p> <p><b>8270-0708 og 8270-0744 er lik men har annet støpsel.</b> <b>Tilsvarende i 12 volt er 8270-0958.</b></p>	
<b>8270-0951</b>	<p style="text-align: center;"><b>12 Volt</b></p> <p><b>Passer på:</b> Mitsubishi, Sabb-Mitsubishi, Sole Diesel</p> <p><b>Erstatter:</b> Mitsubishi: 30A87-00060, MM432305 Sole: 13424025 Akel: 1005 Holdwell: HD46650871</p>	

For å se alle modeller eller andre strl., se hele vårt sortiment på [www.importex24.no](http://www.importex24.no)



## STOPPMAGNETER

STOPPMAGNETER		
Best.nr	Tekn. data	
<b>8270-0952</b>	<p style="text-align: center;"><b>12 Volt Trekk: 19A / Hold: 0,65A</b></p> <p><b>Passer på:</b> Caterpillar, Yanmar</p> <p><b>Erstatter:</b> Yanmar: 129470-67320 Synchrostart/Woodward: SA-3527, 1504-12A7U1B Akel: 3075 Holdwell: HD45018146</p>	
<b>8270-0953</b>	<p style="text-align: center;"><b>12 Volt Trekk: 25A / Hold: 0,6A</b></p> <p><b>Passer på:</b> Scania, Volvo, Volvo-Penta</p> <p><b>Erstatter:</b> Volvo: 3826743, 872826, 876191, 876592, 876788, 881276, 881531, Akel: 4025 Holdwell: HD04400072, HWS0141</p> <p><b>Tilsvarende i 24 volt er 8270-0727.</b></p>	 <p>Sort ledning: Jord Hvit ledning: Kobles mot starters styrestrøm. Rød ledning: Kobles mot pluss over tenning.</p>
<b>8270-0954</b>	<p style="text-align: center;"><b>12Volt</b></p> <p><b>Passer på:</b> Cummins</p> <p><b>Erstatter:</b> 1046103-152 Synchrostart/Woodward: SA-4984, 1751-12E2U1B1 Akel: 2075-2 Holdwell: HD04400216</p>	
<b>8270-0955</b>	<p style="text-align: center;"><b>12 Volt</b></p> <p><b>Passer på:</b> Isuzu, IHI, Fiat- Hitachi, Kobelco</p> <p><b>Erstatter:</b> ISUZU: 897040-4151, 894453-3410, 894453-3411 MV1-58 Holdwell: HD46649649</p> <p><b>Tilsvarende i 24 volt er 8270-0719.</b></p>	

For å se alle modeller eller andre strl., se hele vårt sortiment på [www.importex24.no](http://www.importex24.no)



## STOPPMAGNETER

STOPPMAGNETER		
Best.nr	Tekn. data	
<b>8270-0956</b>	<p style="text-align: center;"><b>12 Volt</b></p> <p><b>Passer på:</b> Cummins, Deutz, KHD Bosch RSV</p> <p><b>Erstatter:</b> Synchrostart/Woodward: SA-3765-12V, 1751-12. Holdwell: HD04100603</p> <p><b>Tilsvarende i 24 volt er 8270-0731.</b></p>	
<b>8270-0957</b>	<p style="text-align: center;"><b>12 Volt</b></p> <p><b>Passer på:</b> Deutz, KHD</p> <p><b>Erstatter:</b> Arrowhead: FSS0078. Deutz: 0410-3808, 0410-3812, 0427-0581. Holdwell: HW04300004</p>	
<b>8270-0958</b>	<p style="text-align: center;"><b>24 Volt</b></p> <p><b>Passer på:</b> Cummins, Yanmar, Kubota m/Cummins</p> <p><b>Erstatter:</b> Cummins: 3931196, 3919423 Synchrostart/Woodward: 1753ES-24A6UC3B1S1 Holdwell: HWS0238</p> <p><b>Tilsvarende i 12 volt er 8270-0950. 8270-0790 er lik men har annet støpsel.</b></p>	
<b>8270-0959</b>	<p style="text-align: center;"><b>12 Volt</b></p> <p><b>Passer på:</b> Nanni / Nogva, Kubota</p> <p><b>Erstatter:</b> Denso: 052600-100 , 052600-1001 , 15471-60010 Kubota: 15471-60010 Holdwell: HD136050105</p>	

For å se alle modeller eller andre strl., se hele vårt sortiment på [www.importex24.no](http://www.importex24.no)

## STOPPMAGNETER

STOPPMAGNETER		
Best.nr	Tekn. data	
<b>8270-0960</b>	<p style="text-align: center;"><b>24 Volt</b></p> <p><b>Passer på:</b> Detroit, Volvo Penta</p> <p><b>Erstatter:</b> Delco: 1118191 Detroit: 23504197 Terex: 0715050433 Trombetta: P515A57V24 Holdwell: HD46651219</p>	
<b>8270-0961</b>	<p style="text-align: center;"><b>12 Volt</b></p> <p><b>Passer på:</b> Mitsubishi SL motorer</p> <p><b>Erstatter:</b> Mitsubishi: 0175-12B7LS Synchrostart/Woodward: SA-4837 Holdwell: SA-4837-12</p>	
<b>8270-0963</b>	<p style="text-align: center;"><b>12 Volt</b></p> <p><b>Passer på:</b> Bobcat, Deutz, Gehl, KHD</p> <p><b>Erstatter:</b> Bobcat: 6680121, 6686715 Deutz: 0427-1996, 0427-2733 Gehl: 133499</p>	
<b>8270-0964</b>	<p style="text-align: center;"><b>24 Volt</b></p> <p><b>Passer på:</b> Scania</p> <p><b>Erstatter:</b> Scania: 1385097, 9231100608 Synchrostart/Woodward: 1751ES-24A7UC13B1A117 Holdwell: HW1385097</p>	





For å se alle modeller eller andre strl., se hele vårt sortiment på [www.importex24.no](http://www.importex24.no)

## STOPPMAGNETER

STOPPMAGNETER		
Best.nr	Tekn. data	
<b>8270-0965</b>	<p style="text-align: center;"><b>12 Volt</b></p> <p><b>Passer på:</b> KHD</p> <p><b>Erstatter:</b> KHD: 01180813, 01181663, 01183253 Holdwell: HW03000001</p> <p><b>Tilsvarende i 24 volt er 8270-0971.</b></p>	
<b>8270-0966</b>	<p style="text-align: center;"><b>12 Volt</b></p> <p><b>Passer på:</b> CAT, JCB, Perkins</p> <p><b>Erstatter:</b> Perkins: 185206084, 185206192, 185206420 185206450, 185206452, U85206451, U85206452 U85206520</p>	
<b>8270-0967</b>	<p style="text-align: center;"><b>12 Volt</b></p> <p><b>Passer på:</b> Bobcat, Kubota</p> <p><b>Erstatter:</b> Bobcat: 6691313, 6691498, 1G925-60011 Kubota: 1G925-60010, 1G925-60011 Synchrostart/Woodward: 1503ES-12A5UC4S Holdwell: HD04400188</p>	
<b>8270-0968</b>	<p style="text-align: center;"><b>12 Volt</b></p> <p><b>Passer på:</b> Kubota</p> <p><b>Erstatter:</b> Synchrostart/Woodward: 1751-12A6U1B1S5, SA-4259</p>	

For å se alle modeller eller andre strl., se hele vårt sortiment på [www.importex24.no](http://www.importex24.no)

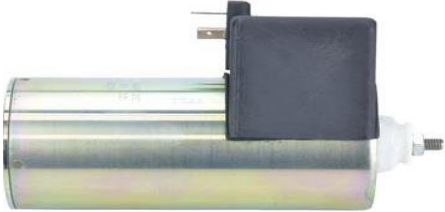
## STOPPMAGNETER

STOPPMAGNETER		
Best.nr	Tekn. data	
<b>8270-0969</b>	<p style="text-align: center;"><b>12 Volt</b></p> <p><b>Passer på:</b> CAT, Cummins</p> <p><b>Erstatter:</b> Synchrostart/Woodward: 1751-12E7U1B1S5A SA-3766T Holdwell: HD04400121</p> <p><b>Tilsvarende i 24 volt er 8270-0747.</b></p>	 <p>HOLD / JORD / TREKK</p>
<b>8270-0970</b>	<p style="text-align: center;"><b>24 Volt</b></p> <p><b>Passer på:</b> CAT</p> <p><b>Erstatter:</b> CAT: 110-6465, 6T4122</p>	
<b>8270-0971</b>	<p style="text-align: center;"><b>24 Volt</b></p> <p><b>Passer på:</b> Deutz, KHD</p> <p><b>Erstatter:</b> KHD: 011779114, 01179933, 01180814, 01181665</p> <p><b>Tilsvarende i 12 volt er 8270-0965.</b></p>	
<b>8270-0972</b>	<p style="text-align: center;"><b>24 Volt</b></p> <p><b>Passer på:</b> Cummins 6BT, Deutz m/Cummins 6BT, Bosch RSV</p> <p><b>Erstatter:</b> Cummins: 3932017, 4942879, 5254169 Synchrostart/Woodward: SA-3742-12V</p> <p><b>Tilsvarende 24 volt er 8270-0788.</b></p>	

For å se alle modeller eller andre strl., se hele vårt sortiment på [www.importex24.no](http://www.importex24.no)

## VOGN /- MOTORLISTE FØDEPUMPER

### AIFO SE IVECO - AIFO

#### BRØYT

Type	Motor	Årsmodell	Best.nr.
GRAVER	PERKINS 6.354		BCD1687-1
GRAVER X20, X21	PERKINS 6.354.4		BCD1942

#### CATERPILLAR - MITSUBISHI

Type	Motor	Årsmodell	Best.nr.
V160/300	PERKINS 6.354		BCD1687-1
VC60C, 660P	PERKINS 4.236		153567

#### CLARK

Type	Motor	Årsmodell	Best.nr.
DC70	PERKINS 4.236		153567/1858*
GAFFELTRUCK	PERKINS 6.354	66-	BCD1687-1
TRAKTOR 45B	PERKINS 6.354		BCD1687-1

\* OPPGI ORG.NR ELLER SE BILDER

#### CUMMINS

Type	Motor	Årsmodell	Best.nr.
INDUSTRI	SERIE "B"		192374

#### DAF

Type	Motor	Årsmodell	Best.nr.
F 1000 CT TURBO	CUMMINS 5,9L DIESEL		192374
FA 500, FA 700	PERKINS 4.236		BCD1858

#### DEUTZ SE KHD

#### FIAT - HITACHI

Type	Motor	Årsmodell	Best.nr.
INDUSTRI	8055.05.200, 8065.05.200		101949
INDUSTRI	8055.25.200 (5SYL)		101949
INDUSTRI	8061.05.200 (6SYL)		101949
INDUSTRI	8065.06.200		101949
INDUSTRI	8065.25.200 TURBOD.		101949
666, 670 TRAKTOR	6SYL		101949
680, 780, 855 TRAKTOR	6SYL		101949

For å se alle modeller eller andre strl., se hele vårt sortiment på [www.importex24.no](http://www.importex24.no)



## VOGN /- MOTORLISTE FØDEPUMPER

<b>FIAT - OM</b>			
Type	Motor	Årsmodell	Best.nr.
DI30	5&6SYL	79-	101949

<b>FORD</b>			
Type	Motor	Årsmodell	Best.nr.
INDUSTRI	D/N DIESEL 4200,6000,6200		158686
INDUSTRI	D/N DIESEL DA10/21,DT17/20		158686

<b>HATZ</b>			
Type	Motor	Årsmodell	Best.nr.
INDUSTRI	2,3,4L31-2,3,4L40	8/88-	8352-70544
INDUSTRI	2,3,4M31-2,4,4M40	8/88-	8352-70544
INDUSTRI	E V9500	8/75-	8352-70544

<b>HYSTER GAFFELTRUCK</b>			
Type	Motor	Årsmodell	Best.nr.
H1100/150F	PERKINS 4.236		153567/1858*
H150, H250	PERKINS 6.354, 6.351.1		BCD1687-1
HB100, H100C, RC150	PERKINS 6.305.1		BCD1687-1
S30/40C	PERKINS 3.152.1, D3.152		127695

\* OPPGI ORG.NR ELLER SE BILDER

<b>INGERSOLL KOMPRESSOR</b>			
Type	Motor	Årsmodell	Best.nr.
85 CFM	PERKINS D3.152		127695*
DRF 250	PERKINS 6.354		BCD1687-1
DR125/140/150	PERKINS 4.236		153567/1858**

\* KAN VÆRE BCD 1987

\*\* OPPGI ORG.NR ELLER SE BILDER

<b>INTERNATIONAL HARVESTER</b>			
Type	Motor	Årsmodell	Best.nr.
474	PERKINS 4.212		153567
585	PERKINS 4.236		153567
1600, 1700, 1800	PERKINS 6.354		BCD1687-1
1822-2022	CUMMINS 6TA 590		192374
HG5	PERKINS 6.354.1		BCD1687-1
JH60, H65	PERKINS 6,354		BCD1687-1

\* OPPGI ORG.NR ELLER SE BILDER

For å se alle modeller eller andre strl., se hele vårt sortiment på [www.importex24.no](http://www.importex24.no)

## VOGN /- MOTORLISTE FØDEPUMPER

<b>IVECO</b>			
Type	Motor	Årsmodell	Best.nr.
40, 50/8, 40/35		79-	101949
40/35AB, 40A/B			101949
50A/B/C, 55A/B			101949
50NC/A, 50NC/B		79-	101949
50NC/C		79-	101949
50/10, 55/10, 55NC		79-	101949
50/8,55/8,65/10			101949
55NC/A, 55NC/B		79-	101949
55NC/C		79-	101949
65 A/B/C, 70 A/B			101949
70/10, 75/10			101949
616 N3/4		79-	101949
A90.14 P, A70.14 P			101949
INDUSTRI	D.8041.05.260		101949
INDUSTRI	D.8045.25.382		101949
INDUSTRI	D.8051.05.200		101949
INDUSTRI	D.8055.05.200/205/250		101949
INDUSTRI	D.8055.25.210		101949
INDUSTRI	D.8050.05.245/246/270/271		101949
INDUSTRI	D.8061.05.260/300		101949
INDUSTRI	D.8062.05.270		101949
INDUSTRI	D.8065.05220/289/290		101949
INDUSTRI	D.8065.05.295/297/300/320		101949
INDUSTRI	D.8065.06.200/300		101949

<b>IVECO - AIFO</b>			
Type	Motor	Årsmodell	Best.nr.
INDUSTRI	8051.05.200		101949

<b>J.C.B</b>			
Type	Motor	Årsmodell	Best.nr.
7, 7C, 8	PERKINS 6.354		BCD1687-1
110	PERKINS 4.248		153567
112	PERKINS 6.354.1		BCD1687-1
114	PERKINS T6.354.1		BCD1687-1
413	PERKINS 6.354		BCD1687-1
418	PERKINS T6.354		BCD1687-1
807	PERKINS 6.354		BCD1687-1
808	PERKINS 6.354		BCD1687-1
808	PERKINS 6354.4		BCD1942

For å se alle modeller eller andre strl., se hele vårt sortiment på [www.importex24.no](http://www.importex24.no)

## VOGN /- MOTORLISTE FØDEPUMPER

<b>KHD</b>			
Type	Motor	Årsmodell	Best.nr.
INDUSTRI	B/F 3,4,5,6 L 912/913 W/T	64-	189662
INDUSTRI	F1/2 FL 511	4/79-	BCD1960
INDUSTRI	F1/2L 410	65-	BCD1960
INDUSTRI	F2L 511		BCD1960
INDUSTRI	F2L 912	3/84-	189662
INDUSTRI	F3L 812 D, F3L 912/912W	64-	189662
INDUSTRI	F3L 913		189662
INDUSTRI	F4L 812 D, F4L 912/912W	64-	189662
INDUSTRI	F5L 912/912W, 912D	64-	189662
INDUSTRI	F6L 812 D, F6L 912/912W	64-	189662

<b>LANDINI</b>			
Type	Motor	Årsmodell	Best.nr.
4500,500 4RM	PERKINS 3.152		135812
8000	PERKINS 4.248		BCD1858
10500, 12500, 13500	PERKINS 6.354.4		BCD1942
14500, 14500 4RM	PERKINS 6.354.4		BCD1942
MF 174, MF 184, MF194 23	PERKINS 4.236		153567
MF 244, 4000, 5000	PERKINS 3.152		127695
MF 1100, 1134, 14500	PERKINS 6.354.4		BCD1942
MF 1104, R9500	PERKINS 6.354.1		BCD1687-1
R6500, R6550, R7500	PERKINS 4.236		153567
R9500 MK II, 4RM	PERKINS 6.354.4		BCD1942
TL 19C, TL 21C	PERKINS D3.152		135812
TL 19N/A, R9500	PERKINS 6.354.1, A6.354.1		BCD1687-1
TL 20C	PERKINS 4.212		153567
TL 20N/A TL20DT	PERKINS 4.236		153567
TL 23	PERKINS 4.248		153567

<b>LOMBARDINI</b>			
Type	Motor	Årsmodell	Best.nr.
INDUSTRI	GRUPPE 8		BCD2570
INDUSTRI	LDW 1204T	-95	BCD2670-3
INDUSTRI	LDW 502, 602, 903,1204		BCD2670-3
INDUSTRI	LDW BF4M, F4M, F3M	-95	BCD2670-3

For å se alle modeller eller andre strl., se hele vårt sortiment på [www.importex24.no](http://www.importex24.no)

## VOGN /- MOTORLISTE FØDEPUMPER

MASSEY FERGUSON			
Type	Motor	Årsmodell	Best.nr.
30/35	PERKINS 4.212		153567/1858*
35, 135	A3.152,AD3.152		135812
122	PERKINS 3.152		127695**
122	PERKINS D3.152		135812
135	PERKINS 3.152, 152UA38570D		127695
135,135ET	PERKINS 3AD.152		135812
135,135ET	PERKINS 3A.144	60-	127695
135, 203, 205	PERKINS A3.152	65-	127695
135/2135	PERKINS D3.152		135812
135MK III, 135V	PERKINS 3AD.152		135812
135MK III, 135V	PERKINS 3A.144	60-	127695
140, 140V	PERKINS 3AD.152		135812
140MK III, 145V	PERKINS 3AD.152		135812
148, 148V	PERKINS D3.152		135812
148MK III, 152, 152ET			135812
150, 203, 2200	PERKINS 3AD.152		135812
152MK III, 152V			135812
165 COMBINE	PERKINS 4.212		153567/1858*
168, 168MK III/168F	PERKINS 4.236		153567
168, 175/175S, 175/178	PERKINS 4.236		BCD1858
175/175S,175/178	PERKINS 4.236		153567
178	PERKINS 4.248		153567
178,185,188	PERKINS 4.248...248UA71960		BCD1858
185, 188, 194	PERKINS 4.248 248UA71961...		153567
186 COMBINE	PERKINS 4.212		BCD1858
206	PERKINS 4.236		153567
235, 245, 255	PERKINS D3.152		135812**
240, 250, 254, 550	PERKINS D3.152		135812
265, 274, 275	PERKINS 4.236		153567
285, 290	PERKINS 4.248		153567
300	PERKINS 4.248		BCD1858
300, 33	PERKINS 4.248		153567
396, 399, 699, 3085, 3095	PERKINS		BCD1942
400X/D, 507, 520, 525			BCD1687-1
500, 507, 525	PERKINS 6.354		BCD1687-1
530, 1250, 2720	PERKINS 6.354.4		BCD1942
565, 575	PERKINS 4.236		153567
590	PERKINS 4.248		153567
600	PERKINS 4.236		153567

\* OPPGI ORG.NR ELLER SE BILDER

\*\* KAN VÆRE ANDRE. OPPGI ORG.NR ELLER SE BILDER.

**For å se alle modeller eller andre strl., se hele vårt sortiment på [www.importex24.no](http://www.importex24.no)**

## VOGN /- MOTORLISTE FØDEPUMPER

<b>MASSEY FERGUSON FORTSETTER</b>			
Type	Motor	Årsmodell	Best.nr.
675, 690			153567
2203-7, 2205-7	PERKINS D3.152		135812
2620, 2640, 2680	PERKINS 6.354.4		BCD1942
3115, 3120, 3125, 3635	PERKINS		BCD1942
3645, 3655, 4260, 4270	PERKINS		BCD1942
6160, 6170, 6180, 6190	PERKINS		BCD1942
8110, 8120, 8130	PERKINS		BCD1942
D400C			BCD1687-1
DX35, DX40, HX210	PERKINS 3AD.152		135812
RX85 33C			BCD1942

\* OPPGI ORG.NR ELLER SE BILDER

\*\* KAN VÆRE ANDRE. OPPGI ORG.NR ELLER SE BILDER.

<b>PERKINS</b>			
Type	Motor	Årsmodell	Best.nr.
INDUSTRI	3A.144, 3.152..1, 3.152TA		127695
INDUSTRI	4.212, 4.236, 4.248		153567/1858*
INDUSTRI	6.354, 6.354.4, T6.354.4		BCD1942
INDUSTRI	A3.152, D3.152		127695
INDUSTRI	D3.152, 3.152, 3AD.152		135812
INDUSTRI	T6.354.1, 6.372, 6.372.4		BCD1942
INDUSTRI	6.354, 6.372	61-	BCD1687-1

\* OPPGI ORG.NR ELLER SE BILDER

<b>SISU</b>			
Type	Motor	Årsmodell	Best.nr.
TRUCK R141, R142, R149, M169	LEYLAND 690		BCD1687-1

<b>VM</b>			
Type	Motor	Årsmodell	Best.nr.
INDUSTRI	104, 106, 954, 956 SU		189662
INDUSTRI	1056, T1056SU, 6105		189662
INDUSTRI	T6105 SUN		189662

<b>VOLVO</b>			
Type	Motor	Årsmodell	Best.nr.
P300, P830	PERKINS 4.236		153567
P827, T500, P838	PERKINS 4.236		153567
F82, F83	PERKINS 4.236		BCD1858
F82,F83,G65,G80,G407	PERKINS 4.236		153567

For å se alle modeller eller andre strl., se hele vårt sortiment på [www.importex24.no](http://www.importex24.no)



## FØDEPUMPER MARINE

### AIFO SE IVECO - AIFO

#### BMC/LEYLAND

Type	Årsmodell	Best.nr.	Merknader
1.5 D		BCD1877	
1.8 D		BCD1877	

#### CUMMINS

Type	Motor	Best.nr.	Merknader
4 B	3,9L	192374	
4 BT	3,9L TURBO	192374	
4 BTA	3,9L TURBO/INT	192374	
6 B	5,9L	192374	
6 BT	5,9L TURBO	192374	
6 BTA	5.9L TURBO/INT	192374	

### DEUTZ SE KHD

#### FORD

Type	Årsmodell	Best.nr.	Merknader
2401		BCD1886	
2700 Serie	1965-73	158686	
2712		158686	
2713		158686	
2715		158686	
2722		158686	
2725		158686	

#### IVECO - AIFO

Type	Årsmodell	Best.nr.	Merknader
8041.05.260		101949	
8061.05.260		101949	
8061.05.300		101949	

#### KHD

Type	Årsmodell	Best.nr.	Merknader
F2L 912		189662	
F3L 812		189662	
F3L 912		189662	
F3L 913		189662	
F4L 812		189662	
F4L 912		189662	
F5L 912		189662	
F6L 812		189662	
F6L 912		189662	

### LEYLAND SE BMC

For å se alle modeller eller andre strl., se hele vårt sortiment på [www.importex24.no](http://www.importex24.no)

## FØDEPUMPER MARINE

<b>LOMBARDINI</b>			
Type	Årsmodell	Best.nr.	Merknader
LDW 194 JMT			
LDW 502		BCD2570 / BCD2670*	
LDW 602		BCD2670	
LDW 702		BCD2570 / BCD2670*	
LDW 903		BCD2670	
LDW 1003		BCD2570 / BCD2670*	
LDW 1204		BCD2670	
LDW 1404		BCD2670	

\*Se bilder

<b>PERKINS</b>			
Type	Årsmodell	Best.nr.	Merknader
3.152		127695	2 Hull
4.99	63 -	BCD1687-1	
4.236		BCD1858	2 Hull
4.236		BCD2567	4 Hull
6.288	63 -	BCD1687-1	
6.305	63 -	BCD1687-1	
6.340	63 -	BCD1687-1	
6.354		BCD1858 / BCD1942*	4 Hull

\*Se bilder. Kan være andre, hvis mulig oppgi org.nr. / se biler

<b>SABB</b>		
Type	Repp. sett for fødepumpe: Best.nr.	Merknader
H, HG	S02672	
2G, 2GRG		
2H, 2HG		
2J, 2JRG		

Til ovenforstående kan vi kun levere rep. sett, ikke komplette pumper.

<b>VETUS</b>			
Type	Motor	Best.nr.	Merknader
M 3.10	3CYL. 22HK	BCD1706	
M 4.14	4CYL. 33HK	BCD1706	

For å se alle modeller eller andre strl., se hele vårt sortiment på [www.importex24.no](http://www.importex24.no)

## FØDEPUMPER MARINE

VOLVO PENTA			
Type	Årsmodell	Best.nr.	Merknader
2001 (84-90)	OPP TIL MOT.NR 2300046825	8352-70544	
2002 (84-90)	OPP TIL MOT.NR 2300046825	8352-70544	
2003 / T (84-90)	OPP TIL MOT.NR 2300046825	8352-70544	
AD30		860320**	
AD, 31, 41, A, B		BCD2310	
AQ115		BCD1706	
AQ130		BCD1706	
AQ165		BCD1706	
AQ170		BCD1706	
AQAD30, 40		BCD2310	
AQAD31, 32, 41		BCD2310	
AQD21		BCD1706***	
AQD30, 31		BCD1706***	
AQD32		BCD1706***	
AQD40, 41		BCD1706***	
KAD32, 41, 42, 43, 44, 300		BCD2310	
KAMD42, 43, 44, 300		BCD2310	
MB10		8352-70544	BENSIN
MD1B		8352-70544	
MD2B		8352-70544	
MD3B		8352-70544	36 HK
MD5		8352-70544	
MD6		8352-70544	
MD7		8352-70544	
MD11		8352-70544	
MD17		8352-70544	
MD21, A, B		BCD1706	
MD30		BCD2310	
MD31		BCD2310	
MD32		BCD1706***	
MD40		BCD2310	
MD42		BCD2310	
MD42		158686****	
MD2010A - D		3580100*	
MD2020A - D		3580100*	
MD2030A - D		3580100*	
MD2040A - D		3580100*	
TAMD30,40		BCD2310	
TAMD31, 41, 42		BCD2310	
TD120C,FG,G	12/78 -	BCD1706	
TMD30, 40		BCD2310	
TMD31, 41, 42		BCD2310	

\* Orginalnr.

\*\* Har utgått, kan bruke BCD2310, men må gjøre om på rør

\*\*\* Kan være andre, hvis mulig oppgi org.nr. / se bilder. Kan være BCD2310

\*\*\*\* Denne kan brukes, men toppen må løsnes og vris. For at membranen skal bli riktig må man holde pumpearmen inne ved sammenskruing

**For å se alle modeller eller andre strl., se hele vårt sortiment på [www.importex24.no](http://www.importex24.no)**

## FØDEPUMPER

101949



PASSER: IVECO-AIFO

127695



PASSER: PERKINS

135812



PASSER: PERKINS

158686



PASSER: FORD

189662



PASSER: KHD

8352-70544

192374

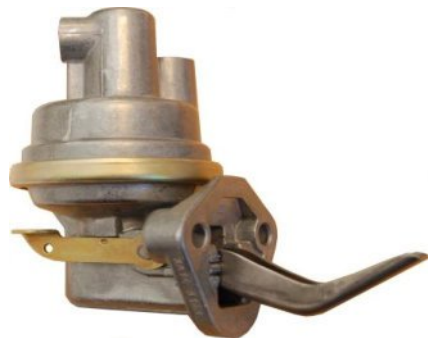

PASSER: CUMMINS

BCD1687-1



PASSER: VOLVO PENTA



PASSER: PERKINS

For å se alle modeller eller andre strl., se hele vårt sortiment på [www.importex24.no](http://www.importex24.no)

## FØDEPUMPER

**BCD1706**



PASSER: VOLVO PENTA, VETUS

**BCD1858**



PASSER: PERKINS

**BCD1877**



PASSER: BMC/LEYLAND

**BCD1942**



PASSER: PERKINS

**BCD2567**



PASSER: PERKINS

**BCD1886**



PASSER: FORD

**BCD2310**



PASSER: VOLVO PENTA

**BCD2670**

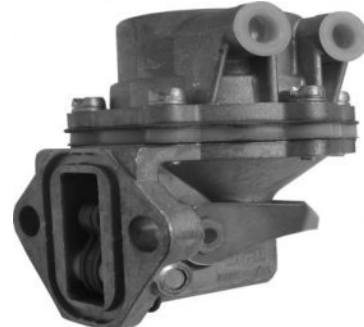

PASSER: LOMBARDINI

For å se alle modeller eller andre strl., se hele vårt sortiment på [www.importex24.no](http://www.importex24.no)



## Vi leverer:

Arco, Delco Remy, Dixie, Elstock, Lucas/CAV  
Mitsubishi, Prestolite/Leece-Neville, Valeo

- Startere, Dynamoer og Boggeløftmotorer til de fleste kjøretøy og maskiner
- Stort utvalg av deler til startere og dynamoer
- Startere, Dynamoer og Dynastartere til marine motorer
- Startere og Dynamoer til utenbordsmotorer
- Tilt-/ Trim motorer til hekkagregater og utenbordsmotorer
- EGR Ventiler
- AC-Kompressorer
- Kupevifter
- Bremsedalipere
- Servopumper
- Reimer og Registerreimer

Benton, Transpo, Mobiletron, Noco

- Regulatorer Likerettere Tenningsmoduler Skilledioder Omformere 24V-12V Converter (12-230V og 24-230V) Batterilader Startbooster

Fiamm

- Horn for bil, lastebil og marine

Blue Sea, MTA, Nagares, Werhle

- Sikringsholdere Sikringer Kabelsko Brytere Releer Tilhengerstøpsel/ kontakter m.m.

Amokabel

- Kabel Standard / Fortinnet ADR godkjent

Amc, Hengst, Wix

- Filter og Filterholdere for Europeisk, Japanske og Amerikanske biler, busser, lastebiler og marine privat og pro

Bullboy, Bullpro, NordicLights, Ocean Vision, SAE  
X-Vision, Seeker, W-Light

- Arbeidslamper Varsellys Ekstralys Markeringslys Frontlys Baklys Lommelykter Hodelykter

Tungstram, Autoline

- Lyspærer

Cohline

- Diesel rekvisita Slanger Nipler Bremsør

BCD, Hardi, Sofabex, Valeo

- Mekaniske fødepumper for diesel og elektriske fødepumper for bensin og diesel

Bosch, Champion, NGK

- Glødeplugg og Tennplugg

CAV, Synchro-Start, Woodward

- Stoppsolenoider

NWB, Valeo

- Vinduspusser blader. Produsert av original leverandør

Bosch

- Viftreimer Kilereimer Multireimer

**ImporteX4**

*Vi sjekker gjerne det "umulige"!*

Torweien 2,

1940 Bjørkelangen

info@importex.no

Ordre/Support: 92 66 97 69